

# 40' x 80' MASTER SERIES FRAME TENT SECTIONAL PRODUCT MANUAL

ver.20170614

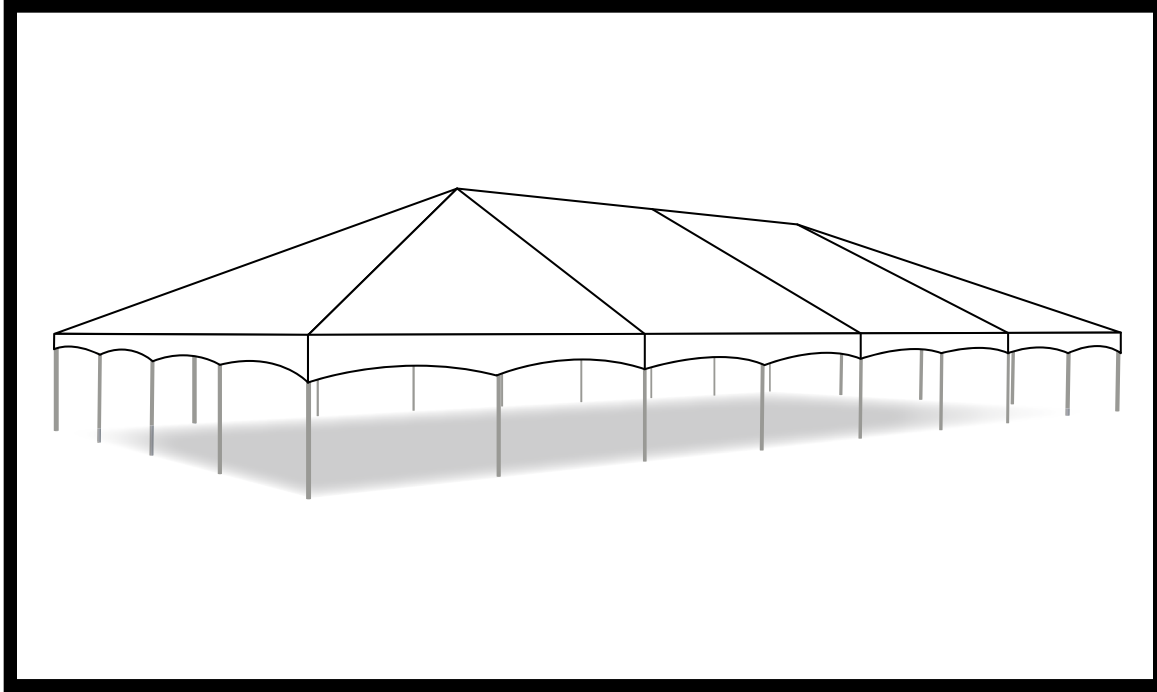

Read this manual before using this product. Failure to do so can result in serious injury.  
**SAVE THIS MANUAL**



## NOTICE

The warnings, cautions, and instructions discussed in this instruction manual cannot cover all possible conditions and situations that may occur. It must be understood by the user that common sense and caution are factors which cannot be built into this product, but must be supplied by the installer and/or user.

Tent, canopy, structure, and shelter products are manufactured for use as temporary structures and do not meet structural code unless specified. Since weather is unpredictable, the installer/end user must incorporate their own good judgment, common sense and knowledge of local conditions with the installation instruction guidelines. The installer is responsible for anticipating weather severity for proper time and method of installation.

## WARNING SYMBOLS AND DEFINITIONS

	This is the safety alert symbol. It is used to alert you to potential personal injury hazards. Obey all safety messages that follow this symbol to avoid possible injury or death.
<b>▲WARNING</b>	Indicates a hazardous situation which, if not avoided, could result in death or serious injury.
<b>▲CAUTION</b>	Indicates a hazardous situation which, if not avoided, could result in minor or moderate injury.

**Description**



**40' x 80' Master Series Frame Tent, Sectional**

Like most Celina Tent frame tents, the Master Series Frame tent utilizes the West Coast Style frame and fittings for compatibility between tents. The design of the Master Series Frame tent is meant to smooth and tighten the traditional look of frame tents by using a tensioned valance, or catenary curve, as opposed to clips or buckles. This allows the Master Series Frame tent to use less hardware, making for faster and easier installations.

**Suggested Equipment**

Drop cloth or ground cloth, sledge hammer, or electric / gas breaker hammer fitted with stake driver bit, stake puller, and frame tent jack/ lift.

**Colors available by special order**

- White & Red (5051)
- White & Green (5052)
- White & Blue (5053)

**Master Series Frame Tent Specifications**

Width	40 ft. / 12.2m
Length	80 ft. / 24.4m
Area	3200 ft <sup>2</sup> / 297.7m <sup>2</sup>
Eave Height	8' / 2.4m
Overall Height	18' / 5.5m
Pitch	10' / 3.0m
Complete Weight Aluminum	2366 Lbs. / 1073 Kg.
Complete Weight Alum. Hybrid	2843 Lbs. / 1290 Kg.
Series / Brand	Master
Class	Frame
Center Pole	No
Style / Shape	Traditional
Expandable	Yes
Custom Printing Available	Yes
Fabric Material	PVC Coated Polyester
Fabric Material Weight	16 oz. / yd <sup>2</sup> / 540 gsm
Fabric Translucency	Blockout
Water Repellency	Waterproof
Flame Resistant	Yes
UV Resistant	Yes
Mold and Mildew Resistant	Yes
Frame / Pole Material	Aluminum
Longest Component	21'10.5" / 6.7m
Persons required for setup	4-8
Occupancy	320 Sit Down Dinner - 533 Cathedral Seating

**SAFETY**

**INSTALLATION**

**MAINTENANCE**

**CONTACTS**

## PERSONAL SAFETY



**STAY ALERT:** Watch what you are doing, and use common sense when installing/striking a tent, canopy, structure, or shelter. Do not setup/strike while under the influence of drugs, alcohol, or medication. A moment of inattention may result in serious personal injury.



**DO NOT OVER LIFT:** The equipment may be heavy and may require 2 or more people to lift and move.



**DO NOT OVERREACH:** Keep proper footing and balance at all times. Use a ladder when necessary.



**DRESS PROPERLY:** Do not wear loose clothing or jewelry. Contain long hair. Keep hair, clothing, and hands/gloves away from power equipment and snag or pinch points.



**USE SAFETY EQUIPMENT:** Eye protection, safety shoes, hard hats, or hearing protection must be used for appropriate conditions.

## WEATHER

Since weather is unpredictable, the installer/end user must incorporate their own judgment, common sense and knowledge of local conditions with the installation instruction guidelines. The installer is responsible for anticipating weather severity for proper time and method of installation.

- **Rain:** **⚠️WARNING** Rain water can collect on the tent fabric and cause 'ponding' or 'water pocketing' under certain weather conditions, especially if the tent is not installed and tensioned correctly. The additional weight from the water will cause the tent to sag and ponding will continue to get worse. The weight can destroy the tent fabric and/or cause the poles and baseplates to sink into the soil. Highly saturated soil will cause the stakes to lose their holding power.
- **Wind:** **⚠️WARNING** Wind or wind and rain can cause the tension of the tent to change by loosening ratchet assemblies, pulling stakes, and or causing the poles to shift or sink. It is very important to do routine maintenance checks and maintain proper tension on the tent top at all times especially if weather conditions are such that ratchets are beginning to loosen.
- **Lightning:** **⚠️WARNING** Immediately evacuate the tent until the chance of a lightning strike is no longer present.
- **Snow:** Tents, canopies, structures, and shelters are not designed to carry any type of snow loading. These products should not be used if snow of any kind is present, and must be evacuated immediately.

## SITE SELECTION

Site selection is extremely important. The installer must adhere to local building codes and fire regulations. The installer must evaluate each installation site and determine the proper securing and anchoring method and device appropriate for the conditions. Some soils require different staking or securing methods than what may be/have been purchased with the standard tent package. Celina Tent's instructions, YouTube videos, and Layout Handbook summarize all the functions of each product, the rules for using them and suggestions for their use. However, field situations, site conditions, weather and local experience may mandate other methods. Review the following conditions at the proposed site and plan accordingly.

The best site qualities are:

- **Location:** Elevated, level, and clear of debris
- **Soil Conditions:** Adequate for stable anchoring
- **Space:** Adequate space for the perimeter and stake lines
- **Surface Type:** Grass, Gravel, Concrete, Asphalt, Wood
- **Site Access:** Materials and services can easily be delivered to the site

**⚠️WARNING** Also allow for:

- **Overhead Obstructions:** Electrical/telephone lines, tree branches
- **Underground Utilities:** Electric, Gas, Oil, Steam, Telephone, CATV, Water, Sewer
- **Weather Effects:** Monitor for extreme weather conditions and evacuate if necessary
- **Emergency Exit Capabilities:** Provide evacuation routes in case of a fire or bad weather

## Before You Stake

By law you are required to contact your local “Call before you dig” number before you plan to dig or drive tent stakes / anchors. After calling, your local utility companies will mark the location of all underground utility lines. Laws from state to state vary on how far in advance you must call. Planning ahead and checking with your state’s program is always a smart idea. Failure to obtain a utility line location before digging can result in a substantial fine or serious injury. Please find your local “call before your dig number” in the contacts section of this manual.

**⚠WARNING** Prior to staking, be sure that no underground utilities are present. Celina is not responsible for methods that installers may choose to erect and secure the tent, canopy, structure, or shelter to the site surface. Celina’s responsibility is limited to the manufacture of the tent parts and materials. It is the installer’s responsibility, not Celina’s, to determine the appropriate number of stakes to meet the necessary wind loads on the installation site.

**⚠WARNING** Soil and setup conditions can vary greatly between installation sites. It is the installer’s responsibility to be sure the staking is adequate for each site on each setup. Additional staking, tiebacks, and/or stake bars may be required in order to safely setup and secure the product.

**⚠WARNING** The number of stakes suggested in this manual routinely does not meet the relevant local codes of the installation site. The number of stakes included in the standard kit will, in most cases, keep the tent, canopy, structure, or shelter setup. Due to various soil conditions the standard staking kit may be inadequate to keep the tent secure in high winds and wet or threatening weather. Regardless of the number of stakes included in standard kits, Celina makes no representation or warranty as to whether this is sufficient to meet the requirements for your installation site(s).

## Staking Basics

A properly driven stake will have 6” or less of the head exposed. The deeper that the stake is driven, the greater holding strength the stake will have. Anchoring stakes must be driven deep and vertical.

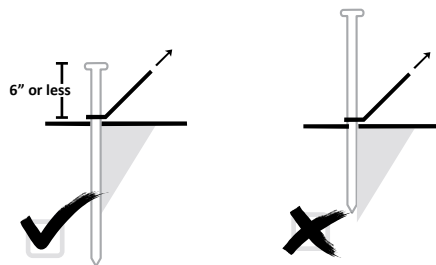



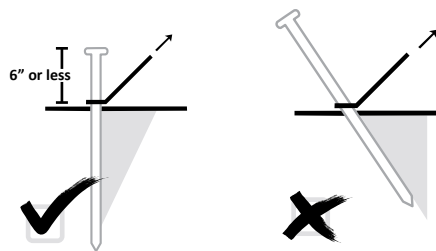







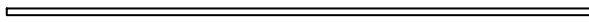
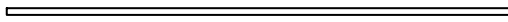
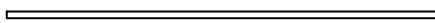
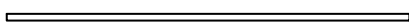



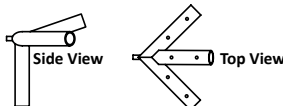
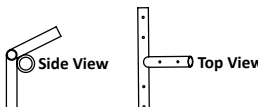
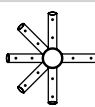
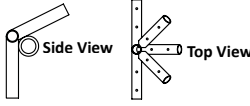
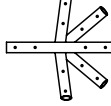
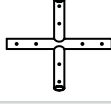
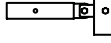

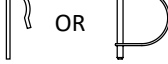

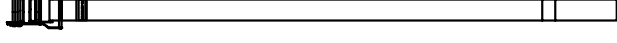
Stakes driven vertically have a greater holding strength than stakes driven at an angle. Vertically is defined as straight up down or angled up to 10° away from the tent, canopy, structure, or shelter.

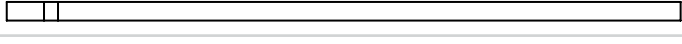

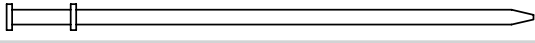
For more information on staking and soil conditions, please view Celina Tent’s 15 part video series on YouTube.com or follow this link: Stake Pull Demonstration (1/15) [www.goo.gl/v0XhV](http://www.goo.gl/v0XhV)

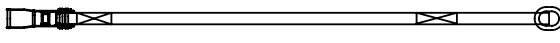
# REQUIRED HARDWARE

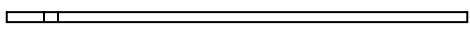
## 40' x 80' Master Series Frame Tent, Sectional

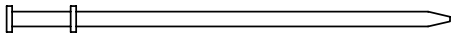
Description (Key)	Size/ Color	Qty.	Picture
Rafter	21'10.5" / Red	12	
Hip Rafter	14'4" / Red	16	
Corner Rafter	10'6" / Green	8	
Spreader	9'4" / White	28	
 Legs	7'8" / Black	24	
Rafter Bar	14'4" / Red	3	
Corner		4	
Side Tee w/ Ring		14	
6 Way Crown		2	
6 Way Side Tee w/ Ring		6	
6 Way Hip Joint		4	
Ridge Crown		3	
Ridge Support Bracket		6	
Master Series Base Plates		24	
R Pin OR Pin & Bail		206	
Cable	40'	5	
 A. Ratchet Buckle with Loop Strap	2" Ratchet w/ 5' Strap/Loop	24	
 B. Loop Strap	8' Strap/Loop	24	
 Double Head Stakes	36" OR 42"	24	
 C. Master Series Ratchet Buckles Loop Strap w/ O Ring	1" Ratchet w/ 4' Strap/Loop	24	
 D. Master Series Loop Strap	6' Strap/Loop	24	
 Double Head Stakes	24"	24	

NOTE: When the Ratchet Buckle with Loop Strap (A/C) is connected to Loop Strap (B/D) it forms the Ratchet Assembly.

SAFETY

INSTALLATION

MAINTENANCE

CONTACTS

## REQUIRED HARDWARE

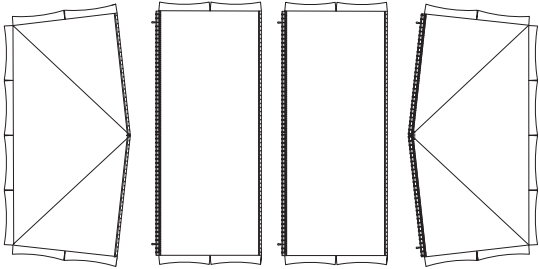
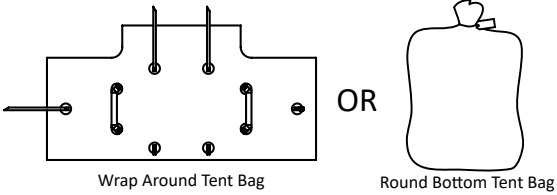
Description (Key)	Size/ Color	Qty.	Picture
Tent Top	40'x80'	4 pc.	
Tent Bag	C	4	 <p style="text-align: center;">Wrap Around Tent Bag      OR      Round Bottom Tent Bag</p>

## OPTIONAL ACCESSORIES

Description (Key)	Size/ Color	Qty.	Picture
Sidewall(s)	20'	6	
Sidewall(s)	30'	4	

## RATCHET ASSEMBLIES

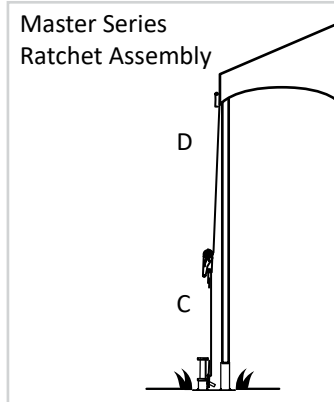
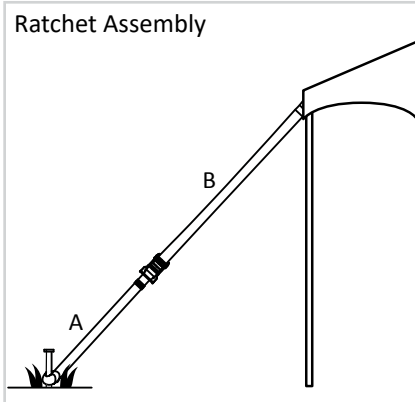

- A. Ratchet Buckle with Loop Strap
- B. Loop Strap
- C. Master Series Ratchet Buckles Loop Strap w/ O Ring
- D. Master Series Loop Strap

# PARTS / MINIMUM STAKING LAYOUT

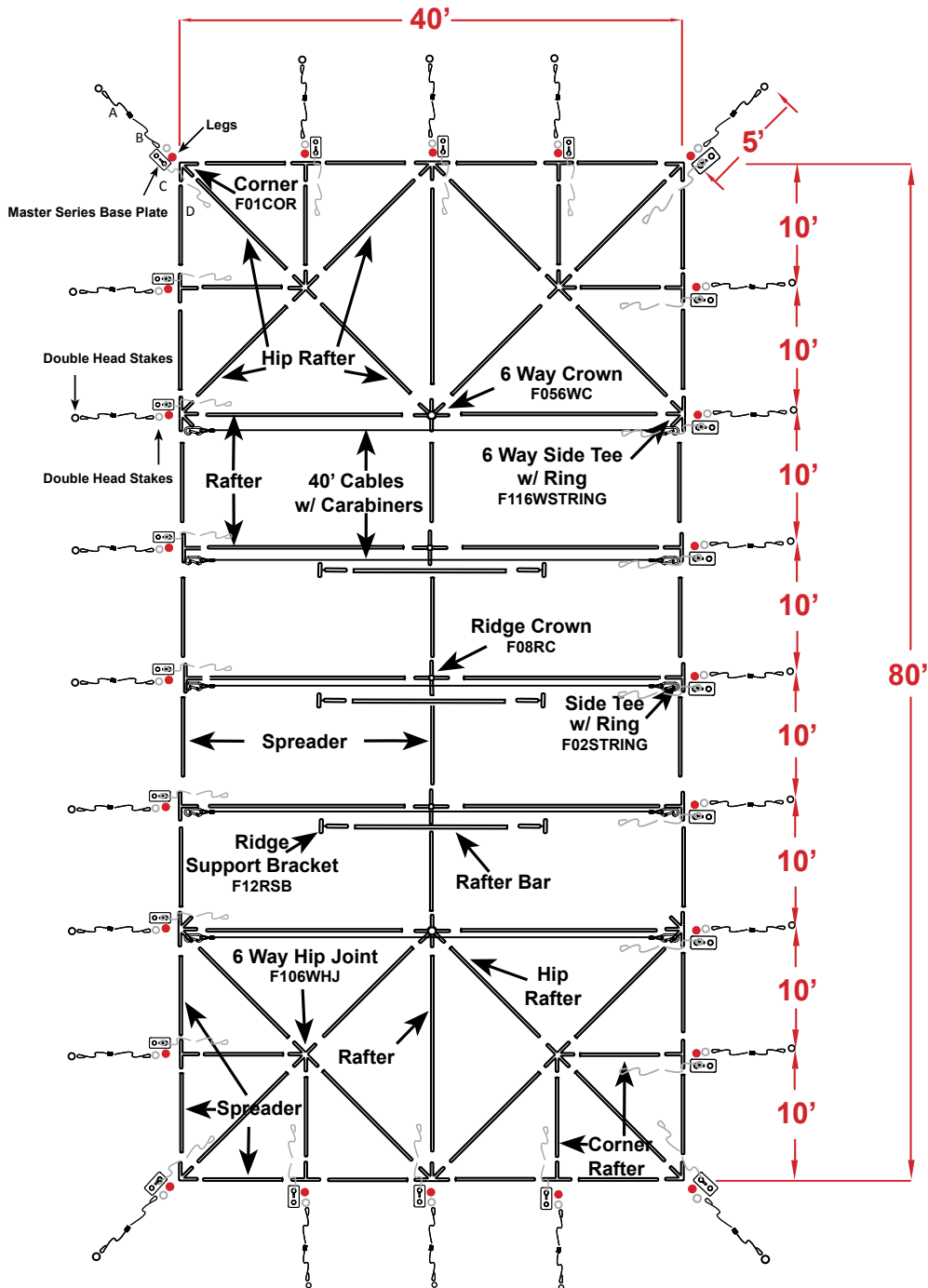
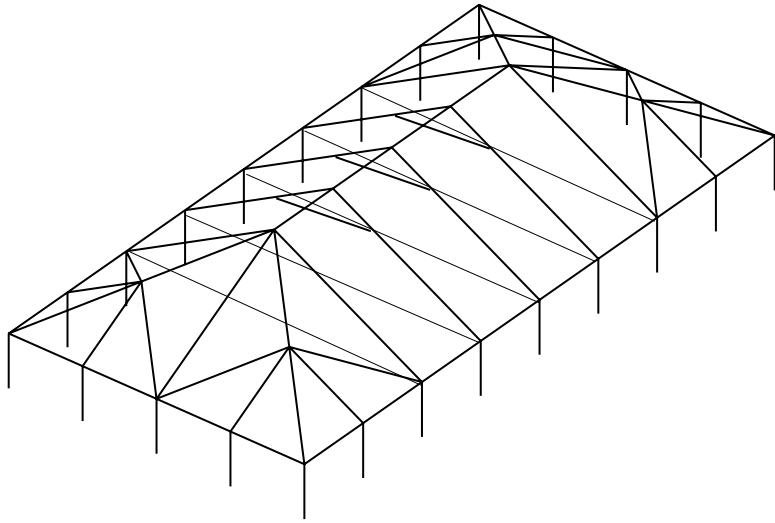

SAFETY

INSTALLATION

MAINTENANCE

CONTACTS

## Set Up Instructions

1. Lay out the frame parts on the ground in the approximate location that they will be when the frame is assembled. (See parts / minimum staking layout diagram)

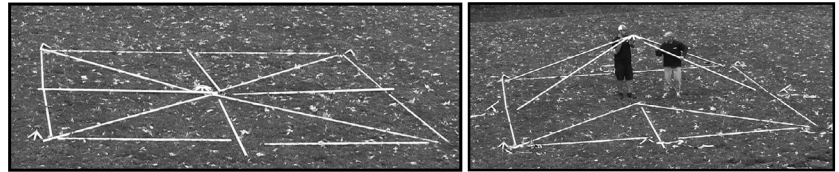

2. Place the 6-way crown in the framework; the protrusions on the crown will alternate between lifted and touching the ground when it is laid on a level surface. All lifted protrusions will point to the hip rafters, angled toward the corners of the tent. The protrusion parallel to the ground will point toward the other 6-way crown.

3. Connect the 6-way crown to the hip rafters (14'4" red):

- a. Each protrusion on the crown has two holes; one closer to the center (the alignment hole) and one further down the protrusion (the placement hole).
- b. Place a pin in the alignment hole; this keeps the rafter from moving too far onto the crown. Slide the tubing onto the protrusion until it meets the pin.
- c. Align the placement hole in the crown with the hole in the rafter and insert a pin.
- d. Remove the alignment hole pin. (\*This procedure applies to all frame fittings)

4. Connect the rest of the tubing in the following order:

- a. To the 6-way crown:
  - i. Rafters (21'10.5" red) to 6-way crown
  - ii. 6-way hip joint to each hip rafter (14'4" red)
  - iii. First spreader (9'4" white) to the 6-way crown
  - iv. First spreader (9'4" white) to first ridge crown
  - v. Rafters (21'10.5" red) to first ridge crown
  - vi. First ridge crown to second spreader (9'4" white)
  - vii. Second spreader (9'4" white) to second ridge crown
  - viii. Rafters (21'10.5" red) to second ridge crown
  - ix. Third spreader (9'4" white) to second ridge crown
  - x. Third ridge crown to third spreader (9'4" white)
  - xi. Rafters (21'10.5" red) to third ridge crown
  - \* Slide the ridge support brackets onto the middle rafters (6-21'10.5" red), one ridge support bracket per rafter. Connect the ridge support brackets with a (14'4" red) rafter bar and pin. Level and lighten.
  - xii. Fourth spreader (9'4" white) to third ridge crown
  - xiii. Fourth spreader (9'4" white) to second 6-way crown; repeat rafter/hip rafter steps
- b. To each 6-way hip joint:
  - i. Hip rafters (14'4" red) to the first, third, and fifth protrusions
  - ii. Corner rafters (10'6" green) to the second and fourth protrusions
- c. 6-way side tee fitting to rafters (21'10.5" red)
- d. Hip rafters (14'4" red) to each 6-way side tee fitting
- e. Side tee fittings to corner rafters (10'6" green)
- f. Side tee fittings to rafters (21'10.5" red)
- g. Corner fittings to hip rafters (14'4" red)
- h. Spreaders (9'4" white) to 6-way side tee fittings
- i. Spreaders (9'4" white) to side tee fittings
- j. Spreaders (9'4" white) to corner fittings



5. Clip one carabiner on the 40' cable to the O ring on the 6 way side tee. Pull the cable across the 40' width and connect the other end of the cable to the 6 way side tee on the adjacent side by clipping the other carabiner to the O ring on the fitting. Repeat at corresponding 6 way side tee location.

6. Clip one carabiner on the 40' cable to the O ring on the side tee. Pull the cable across the 40' width and connect the other end of the cable to the side tee on the adjacent side by clipping the other carabiner to the O ring on the fitting. Repeat at all corresponding side tee locations in between the 6 way side tees.

7. Fasten the loop strap (B) around the fitting at each leg location.

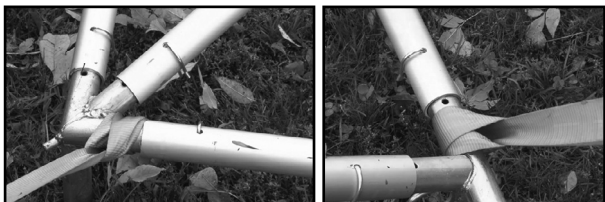

8. Roll out a drop cloth to protect the tent top of dirt and abrasions next to the frame and unroll the tent top pieces. The tent needs to be laid out in the sequence of: 40x20 lace end, 40x20 midsection (x2), 40x20 grommet end. (The midsection has a lace and grommet side; each seam requires one lace line and one grommet line for fastening.)

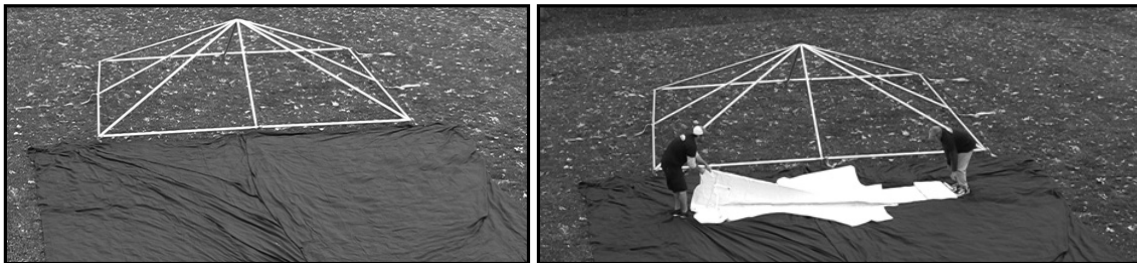

9. Lace the tent together:

- a. Line up each tent sections (the lace end will always be on the bottom) so that they overlap.
- b. Starting in the middle and working toward the edge pull the first lace up through the first small grommet. Pull the second lace up through the second grommet, then through the loop of the first lace.
- c. While lacing the tent, be sure to connect the rain flap to the rope covering the lace line. This eliminates the need to crawl on the tent after it has been laced.
- d. Continue in this fashion until the third grommet from the edge of the tent is reached. The third lace should be twice as long as the other loops (this is referred to as a double loop).
- e. Pull the final two lines through the grommets and loop the second lace from the tent perimeter into the first lace (the lace is now going towards the direction of the double loop). Pull the third lace (double loop) through the second loop. The third lace (double loop) should now be strung through 2 loops (the second loop and the fourth loop).
- f. Tie off just past the third grommet; this secures the entire lace line.
- g. Connect the hook and loop located on the valance section at the end of each lace line.
- h. Repeat this method to secure all other lace lines.



10. Pull the tent top over the frame, lifting up on the fabric or “flapping” it to create a cushion of air. Make sure the tent top is centered from all sides.

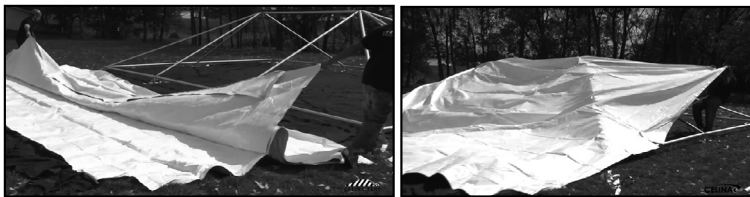

11. Loop the perimeter cord around the outside post of each corner.



12. Fasten the master series loop strap (D) to each corner and each point where valance curves meet by pulling the strap through the two metal rings on the tent top, then through the end loop and tightening.

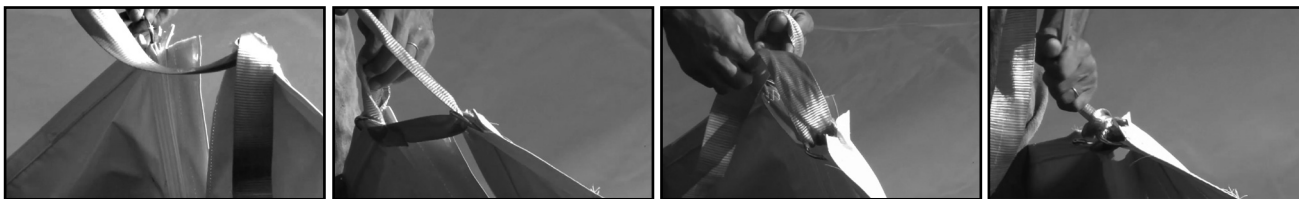

13. Attach the master series base plates to the legs (7’8” black) by sliding the leg tubing over the longer protrusions on the master series base plates, securing with a pin.



14. In windy conditions, locate the downwind side of the tent to lift first; this keeps the wind from catching the tent.

15. Step on the master series base plate to free both hands and lift one side of the tent frame. Do not lift one corner at a time; lift the entire side of the tent. Insert corner fittings into the top of the leg, securing with a pin. Insert all pins from the outside in; this keeps the protruding section of the pin from puncturing the tent fabric. Make sure the staking hole on the base plate is on the outside of the tent.

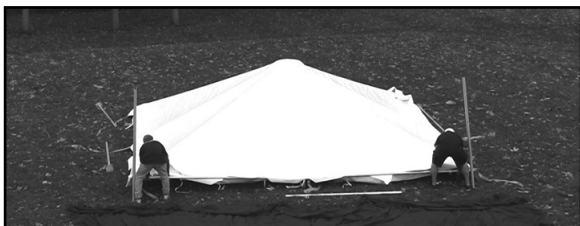

16. Connect the O-ring of the master series ratchet buckle (C) to the base plate hook mounted on the small tubing of the base plate. Feed the master series loop strap (D) attached to the tent top through the reel bars slot of the ratchet (ratchet buckle needs to have handle facing upward at all times) and pull the strap back towards the tent approximately 1 ½ feet. Hold the strap at this point with one hand and begin to crank the ratchet handle back and forth.



17. Repeat with the other side of the tent. When finished with the corner legs, install all other legs at side tee fitting locations. Pull the anchoring devices (ratchet buckle strap) through the tops of the hook and loop extensions on the tent top to provide access to the stakes.

18. Place stakes 5' out from each leg; drive stakes into the ground so that approximately 6" or less of the stake is showing.

19. Attach the ratchet buckle with loop straps (A) to the stakes by turning the 6" loop at the end of the ratchet inside out and pull the strap through the loop to create a noose and pull tight over the stake. Take the loop strap (B) attached to the tent and pull it through the reel bars slot of the ratchet (ratchet buckle needs to have handle facing upward at all times) and pull the loop strap (B) back towards the tent approximately 1 ½ feet. Hold the strap at this point with one hand and begin to crank the ratchet handle back and forth.



20. Make sure the legs are straight then secure the master series base plates by driving a double-headed stake through the smaller tubing on the master series base plate. Tighten all ratchet assemblies.

21. Roll excess ratchet straps and secure into the ratchet buckle.



22. The tent top should now be complete. If sidewalls are desired, unroll the sidewalls between the stakes and the legs around the perimeter of the tent. Starting at a leg, clip the sidewall snap hooks to the rope line that is attached to the tent top

**Sidewall Rope Tensioning:** For new tents and during its life cycle, it may be necessary to tighten the sidewall support rope that runs the perimeter of the tent top. After the tent has been set up and tensioned, locate the corner where the sidewall rope starts and stops. Securely tie off one end of the rope. While pulling against the tie-off point, work your way around the perimeter of the tent, pulling out any unnecessary rope slack. Tie off the opposite end of the rope once reached.

## Striking Instructions

1. Loosen all ratchet assemblies.
2. Remove stakes from master series base plates.
3. Remove interior side tee ratchet assemblies.
4. Remove the side legs leaving the 4 corner legs.
5. Unfasten all anchoring devices from the perimeter tubing (with the exception of 2 at each corner).
6. Remove 2 corner legs from one side and carefully set the tent frame on the ground.
7. Repeat with opposite side.
8. Unfasten the rest of the straps, completely disconnecting the tent top from the frame and stakes.
9. Roll out a drop cloth next to the frame.
10. Carefully remove the tent top from the frame, lifting up on the fabric or “flapping” it to create a cushion of air.
11. Unlace the tent top:
  - a. Separate the valance hook and loop that connects the tents together. Unclip the rain flap until the lace line tie-off is accessed.
  - b. Untie knot and unlace the tent top section while disconnecting the rain flap.
12. Fold and roll the tent top as tight as possible. Remember not to stand or walk on the tent top fabric.
13. Bagging (always use a drop cloth to protect the tent top from dirt and abrasions while bagging):
  - a. For Wrap-Around Tent Bag:
    - i. Lay the bag next to the tent top with the side-release buckles facing down. Roll the tent top onto the center of the bag.
    - ii. Connect the two short male and female side-release buckles; pull tight.
    - iii. Connect the remaining side-release buckle and pull tight.
  - b. For Round-Bottom Bag:
    - i. Place the folded tent top into the upright vertical position.
    - ii. Pull the round bottom tent bag over the upright tent top.
    - iii. Turn the tent top and bag over, pull the draw string tight and tie off.
14. Fold and roll up the drop cloth.
15. Disassemble all of the corner, side tees, hip joints, and crown fittings by removing the pins and sliding the tubing off of the fittings. Work from the perimeter of the frame inward.
16. Remove remaining stakes.



## FLAME RESISTANCE

Celina fabrics are inherently flame resistant. Open flames should never be used under any tent, canopy, structure, or shelter. Fabrics meet or exceed one or more of the following flammability specifications:

NFPA-701	CPAI-84	ASTM D 6413
BS 5438	BS 7837 (1996)	DIN 4102-B1

## TENT CARE

For maximum life of Celina fabrics, Celina recommends regular cleaning with the use of a soft brush with neutral soaps or cleaners, such as Celina Cleaning Products, Ivory dish soap, or warm water. Thorough rinsing and drying is required before storing the fabric.

### Things that will cause premature degradation and may reduce life expectancy of a tent:

- Improper handling during installation/dismantling on rough surfaces will create pinholes and abrasions. ALWAYS USE A DROP CLOTH/GROUND CLOTH DURING INSTALLATION AND DISMANTLING.
- Walking on the fabric during installation/dismantling will create pinholes and abrasions.
- Extended use of the tent without cleaning
- Accumulation of dirt on the vinyl surface will promote the growth of mold and mildew and premature wear.
- Storage of vinyl that has not been dried thoroughly. Even a slightly damp product can promote the growth of mildew when folded and stored. Mold and mildew may require harsh cleaners to remove, which may cause premature wear. The best solution is to take every precaution to keep mold and mildew from growing in the first place. NEVER STORE A TENT, CANOPY, STRUCTURE, OR SHELTER IN A WET OR DAMP CONDITION.
- Harsh detergents and cleaners, which contain a solvent or bleach. The longer the exposure of PVC vinyl to these products, the more it will reduce the life of the PVC vinyl.
- High-abrasive cleaners, including wire brushes, power washers and/or commercial washing machines will result in premature wear and deterioration of tent fabrics.
- Wind whip – Loosely tensioned fabric that whips in the wind will damage over time.

### Vinyl Repair

Celina's repair products provide an easy solution to tears, punctures, or holes. Repair kits and tools are available online at [www.GetTent.com](http://www.GetTent.com) or by contacting Celina.

## PRODUCT WARRANTY

Celina Tent Inc. warrants that this product will be free from defects in material and workmanship for a period of one (1) year following the date of purchase. Defects are limited to any defect which is a result of the manufacturing process. Excluded are holes, punctures, or other damages which can be caused during normal installation of a tent whenever proper procedures are not followed. Celina at its option will repair or replace this product or any component of product found to be defective during this warranty period. This warranty is valid for the original purchaser only, and is not transferable. This warranty does not cover normal wear or damage resulting from negligent use or misuse of the product, use contrary to instructions, repairs or alterations by anyone other than Celina, or forces of nature. Celina Tent is not responsible for methods that installers may choose to erect and secure the tent to the ground. Celina's responsibility is limited to the manufacture of the tent parts and materials.

This warranty is in lieu of all other warranties, and there are no warranties, expressed or implied, including warranties of merchantability of fitness for a particular purpose, which extend beyond the description on the face hereof. Celina Tent Inc. shall not be liable for any incidental or consequential damages. Some jurisdictions do not allow the exclusion of implied warranties or the imitation on incidental or consequential damages, so the above exclusions and limitations may not apply to you.

# CALL BEFORE YOU DIG OR STAKE

STATE	CENTER	PHONE
Alabama	Alabama Line Location	800/292-8525
Alaska	Locate Call Center of Alaska	800/478-3121
Arizona	Arizona Blue Stake	800/782-5348
Arkansas	Arkansas One Call System	800/482-8998
California	Underground Service Alert	800/227-2600
Colorado	Utility Notification Center of Colorado	800/922-1987
Connecticut	Call Before You Dig	800/922-4455
Delaware	Miss Utility of Delaware	800/282-8555
Florida	Call Sunshine	800/432-4770
Georgia	Utilities Protection Center	800/282-7411
Hawaii	Underground Service Alert North	800/227-2600
	Underground Service Alert South	800/227-2600
Idaho	Palouse Empire Underground	800/822-1974
	Utilities Underground Location Center	800/424-5555
	Dig Line	800/342-1585
	One Call Concepts - Idaho	800/626-4950
	Shoshone County One Call	800/398-3285
Illinois	Chicago Utility Alert Network	800/892-0123
Indiana	Indiana Underground Plant Protection	800/382-5544
Iowa	Underground Plant Location Service	800/292-8989
Kansas	Kansas One-Call Center	800/344-7233
Kentucky	Kentucky Underground Protection	800/752-6007
Louisiana	Louisiana One Call System	800/272-3020
Maine	Dig Safe - Maine	888/344-7233
Maryland	Miss Utility	800/257-7777
	Miss Utility of DESMARVA	800/282-8555
Massachusetts	Dig Safe-Massachusetts	888/344-7233
Michigan	Miss Dig System	800/482-7171
Minnesota	Gopher State One Call	800/252-1166
Mississippi	Mississippi One Call System	800/227-6477
Missouri	Missouri One Call System	800/344-7483
Montana	Utilities Underground Location Center	800/424-5555
	Montana U-Dig	800/551-8344
Nebraska	Diggers Hotline	800/331-5666
Nevada	Underground Service Alert North	800/227-2600
New Hampshire	Dig Safe-New Hampshire	888/344-7233
New Jersey	Garden State Underground	800/272-1000
New Mexico	New Mexico One Call System	800/321-2537
	Las Cruces-Dona Ana Utility Council	888/526-0400

STATE	CENTER	PHONE
New York	Dig Safely New York	800/926-7962
	New York City-Long Island One Call	800/272-4480
North Carolina	North Carolina One Call	800/634-4949
North Dakota	North Dakota One Call	800/795-0555
Ohio	Ohio Utilities Protective Service	800/362-2764
	Oil & Gas Producers Underground	800/925-2988
Oklahoma	Call Okie	800/522-6543
Oregon	Oregon Utilities Notification Center	800/332-2344
Pennsylvania	Pennsylvania One Call System	800/242-1776
Rhode Island	Dig Safe-Rhode Island	888/344-7233
South Carolina	Palmetto Utility Protection Service	800/922-0983
South Dakota	South Dakota One Call	800/781-7474
Tennessee	Tennessee One-Call System	800/351-1111
Texas	Texas One Call System	800/245-4545
	Texas Excavation Safety System	800/344-8377
	Lone Star Notification System	800/669-8344
Utah	Blue Stakes Location Center	800/622-4111
Vermont	Dig Safe - Vermont	888/344-7233
Virginia	Miss Utility of Virginia	800/552-7001
	Miss Utility	800/257-7777
Washington	Miss Utility of DELMARVA	800/441-8355
	Notification Center	800/424-5555
	Utilities Council of Cowlitz County	360/425-2506
	Upper Yakima City Underground	800/553-4344
	Inland Empire Utility Coordinating	509/456-8000
West Virginia	Miss Utility of West Virginia	800/245-4848
Wisconsin	Diggers Hotline	800/242-8511
Wyoming	Wyoming One Call	800/348-1030
	Call Before you Dig Wyoming	800/849-2476
District of Columbia	Miss Utility	800/257-7777
Canada	Alberta One Call	800/242-3447
	Ontario	800/400-2255
	Info-Excavation (Quebec)	800/663-9228
	BC One Call	800/474-6886
	Manitoba - Winnipeg	240/480-1212
	Manitoba & Saskatchewan Safe	800/827-5094

SAFETY

INSTALLATION

MAINTENANCE

## SUPPORT

**For technical questions or replacement parts, please contact:**

Celina Tent, Inc. / GetTent.com  
 5373 State Route 29  
 Celina, Ohio 45822-9210 USA

**Telephone:** 419-586-3610

**Fax:** 419-584-0949

**Website:** www.GetTent.com

**Email:** support@celinatent.com

**YouTube:** <http://www.youtube.com/user/celinatent>

**Facebook:** <http://www.facebook.com/celinatent>

**Google +:** <http://goo.gl/qvVdv>

**Twitter:** <http://twitter.com/celinatent>

**LinkedIn:** <http://www.linkedin.com/company/celina-tent-fabric-structures>

CONTACTS