

20' x 30' CLASSIC SERIES GABLE FRAME TENT SECTIONAL PRODUCT MANUAL

ver.20140821



Read this manual before using this product. Failure to do so can result in serious injury.

SAVE THIS MANUAL

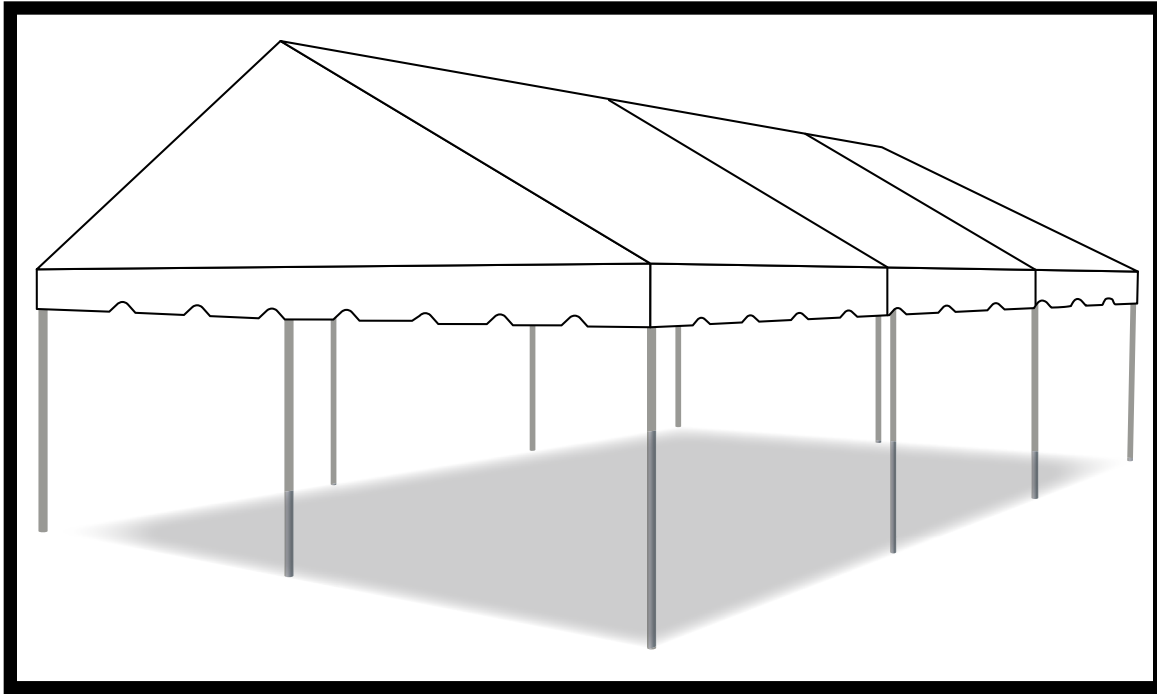

NOTICE

The warnings, cautions, and instructions discussed in this instruction manual cannot cover all possible conditions and situations that may occur. It must be understood by the user that common sense and caution are factors which cannot be built into this product, but must be supplied by the installer and/or user.

Tent, canopy, structure, and shelter products are manufactured for use as temporary structures and do not meet structural code unless specified. Since weather is unpredictable, the installer/end user must incorporate their own good judgment, common sense and knowledge of local conditions with the installation instruction guidelines. The installer is responsible for anticipating weather severity for proper time and method of installation.

WARNING SYMBOLS AND DEFINITIONS

	This is the safety alert symbol. It is used to alert you to potential personal injury hazards. Obey all safety messages that follow this symbol to avoid possible injury or death.
▲WARNING	Indicates a hazardous situation which, if not avoided, could result in death or serious injury.
▲CAUTION	Indicates a hazardous situation which, if not avoided, could result in minor or moderate injury.

Description



20' x 30' Classic Series Gable Frame Tent, Sectional

Classic Series Gable Frame tents are a slight alternative to the Classic Frame tent by providing a gable at each end. Gable Frame tents are ideal for situations requiring the tent to be installed as an extension to a building, used to cover a walk way, or connecting two separated buildings or structures. The Gable ends help eliminate water runoff that a standard tent would have allow at the entry of a tent. The Gable Frame tent has a stylish scalloped valance providing its traditional appearance.

Suggested Equipment

Drop cloth or ground cloth, sledge hammer, or electric / gas breaker hammer fitted with stake driver bit, stake puller, and frame tent jack/ lift.

Colors available by special order

- White & Red (5051)
- White & Green (5052)
- White & Blue (5053)

Classic Series Gable Frame Tent Specifications

Width	20 ft. / 6.1m	
Length	30 ft. / 9.1m	
Area	600 ft ² / 55.5 m ²	
Eave Height	7' / 2.1m	8' / 2.4m
Overall Height	12' / 3.7m	13' / 4.0m
Pitch	5' / 1.5m	
Complete Weight Aluminum	604 Lbs. / 274 Kg.	618Lbs. / 280 Kg.
Complete Weight Galvanized	704 Lbs. / 319 Kg.	728 Lbs. / 319 Kg.
Complete Weight Aluminum Hybrid	790Lbs. / 330 Kg.	810 Lbs. / 358 Kg.
Series / Brand	Classic	
Class	Frame	
Center Pole	No	
Style / Shape	Gable	
Expandable	Yes	
Custom Printing Available	Yes	
Fabric Material	PVC Coated Polyester	
Fabric Material Weight	16 oz. / yd ² / 540 gsm	
Fabric Translucency	Blockout	
Water Repellency	Waterproof	
Flame Resistant	Yes	
UV Resistant	Yes	
Mold and Mildew Resistant	Yes	
Frame / Pole Material	Aluminum OR Galvanized	
Longest Component Alum.	10'6" / 3.2m	
Persons required for setup	3-5	
Occupancy	60 Sit Down Dinner - 100 Cathedral Seating	

SAFETY

INSTALLATION

MAINTENANCE

CONTACTS

PERSONAL SAFETY



STAY ALERT: Watch what you are doing, and use common sense when installing/striking a tent, canopy, structure, or shelter. Do not setup/strike while under the influence of drugs, alcohol, or medication. A moment of inattention may result in serious personal injury.



DO NOT OVER LIFT: The equipment may be heavy and may require 2 or more people to lift and move.



DO NOT OVERREACH: Keep proper footing and balance at all times. Use a ladder when necessary.



DRESS PROPERLY: Do not wear loose clothing or jewelry. Contain long hair. Keep hair, clothing, and hands/gloves away from power equipment and snag or pinch points.



USE SAFETY EQUIPMENT: Eye protection, safety shoes, hard hats, or hearing protection must be used for appropriate conditions.

WEATHER

Since weather is unpredictable, the installer/end user must incorporate their own judgment, common sense and knowledge of local conditions with the installation instruction guidelines. The installer is responsible for anticipating weather severity for proper time and method of installation.

- **Rain:** **⚠️WARNING** Rain water can collect on the tent fabric and cause 'ponding' or 'water pocketing' under certain weather conditions, especially if the tent is not installed and tensioned correctly. The additional weight from the water will cause the tent to sag and ponding will continue to get worse. The weight can destroy the tent fabric and/or cause the poles and baseplates to sink into the soil. Highly saturated soil will cause the stakes to lose their holding power.
- **Wind:** **⚠️WARNING** Wind or wind and rain can cause the tension of the tent to change by loosening ratchet assemblies, pulling stakes, and or causing the poles to shift or sink. It is very important to do routine maintenance checks and maintain proper tension on the tent top at all times especially if weather conditions are such that ratchets are beginning to loosen.
- **Lightning:** **⚠️WARNING** Immediately evacuate the tent until the chance of a lightning strike is no longer present.
- **Snow:** Tents, canopies, structures, and shelters are not designed to carry any type of snow loading. These products should not be used if snow of any kind is present, and must be evacuated immediately.

SITE SELECTION

Site selection is extremely important. The installer must adhere to local building codes and fire regulations. The installer must evaluate each installation site and determine the proper securing and anchoring method and device appropriate for the conditions. Some soils require different staking or securing methods than what may be/have been purchased with the standard tent package. Celina Tent's instructions, YouTube videos, and Layout Handbook summarize all the functions of each product, the rules for using them and suggestions for their use. However, field situations, site conditions, weather and local experience may mandate other methods. Review the following conditions at the proposed site and plan accordingly.

The best site qualities are:

- **Location:** Elevated, level, and clear of debris
- **Soil Conditions:** Adequate for stable anchoring
- **Space:** Adequate space for the perimeter and stake lines
- **Surface Type:** Grass, Gravel, Concrete, Asphalt, Wood
- **Site Access:** Materials and services can easily be delivered to the site

⚠️WARNING Also allow for:

- **Overhead Obstructions:** Electrical/telephone lines, tree branches
- **Underground Utilities:** Electric, Gas, Oil, Steam, Telephone, CATV, Water, Sewer
- **Weather Effects:** Monitor for extreme weather conditions and evacuate if necessary
- **Emergency Exit Capabilities:** Provide evacuation routes in case of a fire or bad weather

Before You Stake

By law you are required to contact your local “Call before you dig” number before you plan to dig or drive tent stakes / anchors. After calling, your local utility companies will mark the location of all underground utility lines. Laws from state to state vary on how far in advance you must call. Planning ahead and checking with your state’s program is always a smart idea. Failure to obtain a utility line location before digging can result in a substantial fine or serious injury. Please find your local “call before your dig number” in the contacts section of this manual.

⚠WARNING Prior to staking, be sure that no underground utilities are present. Celina is not responsible for methods that installers may choose to erect and secure the tent, canopy, structure, or shelter to the site surface. Celina’s responsibility is limited to the manufacture of the tent parts and materials. It is the installer’s responsibility, not Celina’s, to determine the appropriate number of stakes to meet the necessary wind loads on the installation site.

⚠WARNING Soil and setup conditions can vary greatly between installation sites. It is the installer’s responsibility to be sure the staking is adequate for each site on each setup. Additional staking, tiebacks, and/or stake bars may be required in order to safely setup and secure the product.

⚠WARNING The number of stakes suggested in this manual routinely does not meet the relevant local codes of the installation site. The number of stakes included in the standard kit will, in most cases, keep the tent, canopy, structure, or shelter setup. Due to various soil conditions the standard staking kit may be inadequate to keep the tent secure in high winds and wet or threatening weather. Regardless of the number of stakes included in standard kits, Celina makes no representation or warranty as to whether this is sufficient to meet the requirements for your installation site(s).

Staking Basics

A properly driven stake will have 6” or less of the head exposed. The deeper that the stake is driven, the greater holding strength the stake will have. Anchoring stakes must be driven deep and vertical.

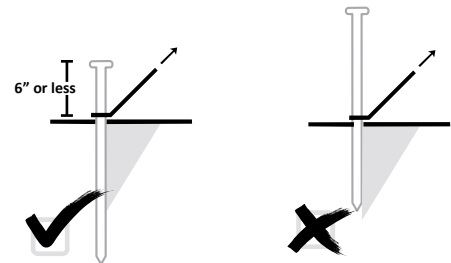

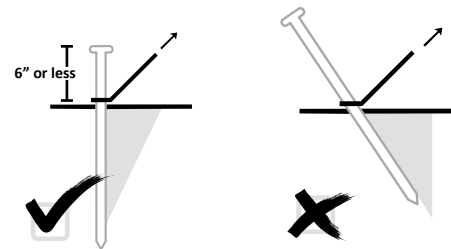

Stakes driven vertically have a greater holding strength than stakes driven at an angle. Vertically is defined as straight up down or angled up to 10° away from the tent, canopy, structure, or shelter.



For more information on staking and soil conditions, please view Celina Tent’s 15 part video series on YouTube.com or follow this link: Stake Pull Demonstration (1/15) www.goo.gl/v0XhV

REQUIRED HARDWARE

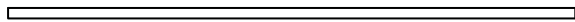
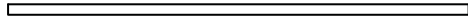
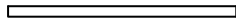
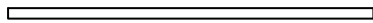
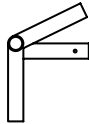
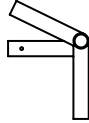
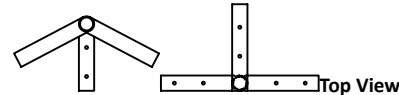
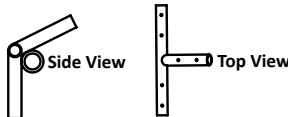
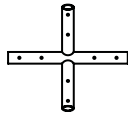
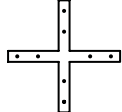
20' x 30' Classic Series Gable Frame Tent, Sectional

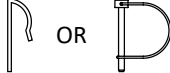
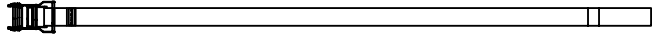
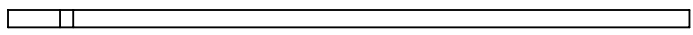
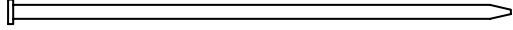
Description (Key)	Size/ Color	Qty.	Picture
Rafter	10'6" / Green	8	
Spreader	9'4" / White	13	
Top Support	4'4" / White	2	
Legs	6'8" (7'8") / Brown(Black)	10	
Gable Left Corner		2	
Gable Right Corner		2	
4 Way Gable Crown		2	
Side Tee w/ Ring		4	
Ridge Crown		2	
4 Way Flat Tee		2	
Base Plate		10	
R Pin OR Pin & Bail		70	
A. Ratchet Buckle with Loop Strap	2" Ratchet 5' Loop	10	
B. Loop Strap	8' Loop	10	
Single Head Stakes	36"	10	

NOTE: When the Ratchet Buckle with Loop Strap A is connected to Loop Strap B it forms the Ratchet Assembly.

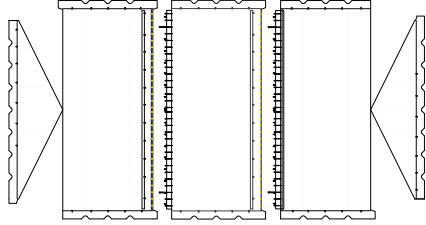
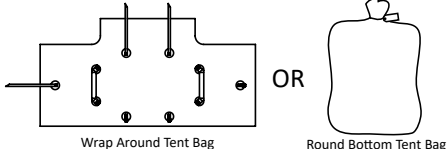
Tent Top	20'x30'	3 pc.	
Tent Bag	B	3	

SAFETY

INSTALLATION

MAINTENANCE

CONTACTS

OPTIONAL ACCESSORIES

Sidewall(s)	20'	2	
Sidewall(s)	30'	2	

PARTS / MINIMUM STAKING LAYOUT

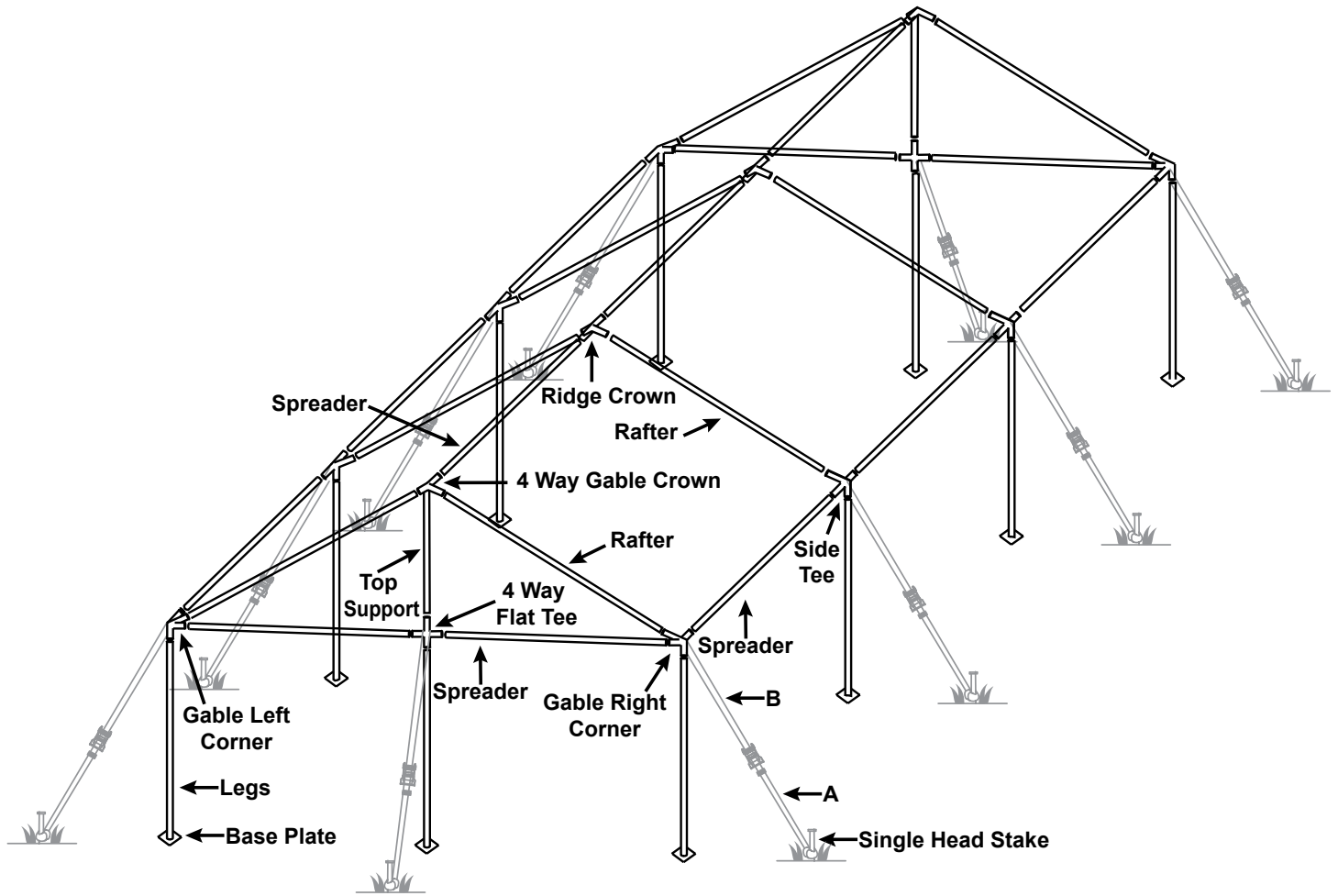
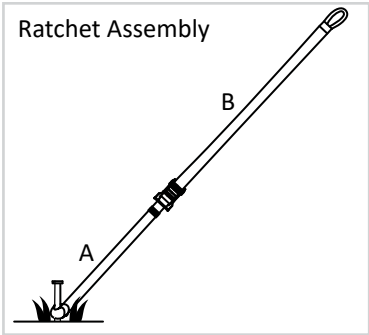

SAFETY

INSTALLATION

MAINTENANCE

CONTACTS

Set Up Instructions

1. Layout the frame parts on the ground in the approximate location that they will be when the frame is assembled. (See parts / minimum staking layout diagram)
2. Connect the 4 way gable crown to the rafters (10'6" green):
 - a. Each protrusion on the crown has two holes; one closer to the center (the alignment hole) and one further down the protrusion (the placement hole).
 - b. Place a pin in the alignment hole; this keeps the rafter from moving too far onto the crown. Slide the tubing onto the protrusion until it meets the pin.
 - c. Align the placement hole in the crown with the hole in the rafter and insert a pin.
 - d. Remove the alignment hole pin. (*This procedure applies to all frame fittings)
3. Connect the rest of the tubing in the following order:
 - a. First top support (4'4" white) to first 4 way gable crown
 - b. First spreader (9'4" white) to first 4 way gable crown
 - c. First ridge crown to first spreader (9'4" white)
 - d. Rafters (10'6" green) to first ridge crown
 - e. Second spreader (9'4" white) to first ridge crown
 - f. Second ridge crown to second spreader (9'4" white)
 - g. Rafters (10'6" green) to second ridge crown
 - h. Third spreader (9'4" white) to second ridge crown
 - i. Third spreader (9'4" white) to second 4 way gable crown
 - j. Rafters (10'6" green) to second 4 way gable crown
 - k. Second top support (4'4" white) to second 4 way gable crown
 - l. Side tee fittings to middle rafters (10'6" green)
 - m. Gable left- and gable right corner fittings to rafters (10'6" green)
 - n. 4-way flat tee fittings to top supports (4'4" white)
 - o. Spreaders (9'4" white) to side tee fittings
 - p. Spreaders (9'4" white) to 4 way flat tee fittings
 - q. Spreaders (9'4" white) to gable corner fittings



4. Fasten the loop strap (B) around the fitting at each leg location.

5. Roll out a drop cloth to protect the tent top of dirt and abrasions next to the frame and unroll the tent top. The tent needs to be laid out in the sequence of: 20x10 lace end, 20x10 mid section, 20x10 grommet end. (The mid section has a lace and grommet side; each seam requires one lace line and one grommet line for fastening.)

6. Lace the tent together:
 - a. Line up each tent section (the lace end will always be on the bottom) so that they overlap.
 - b. Starting in the middle and working toward the edge pull the first lace up through the first small grommet. Pull the second lace up through the second grommet, then through the loop of the first lace.
 - c. While lacing the tent, be sure to connect the rain flap to the rope covering the lace line. This eliminates the need to crawl on the tent after it has been laced.
 - d. Continue in this fashion until the third grommet from the edge of the tent is reached. The third lace should be twice as long as the other loops (this is referred to as a double loop).
 - e. Pull the final two lines through the grommets and loop the second lace from the tent perimeter into the first lace (the lace is now going towards the direction of the double loop). Pull the third lace (double loop) through the second loop. The third lace (double loop) should now be strung through 2 loops (the second loop and the fourth loop).
 - f. Tie off just past the third grommet; this secures the entire lace line.
 - g. Connect the hook and loop located on the valance section at the end of each lace line.
 - h. Repeat this method to secure all other lace lines.



7. Pull the tent top over the frame, lifting up on the fabric or “flapping” it to create a cushion of air.

8. Loosely fasten 2 alligator straps at each corner around the perimeter tubing to secure the tent top.

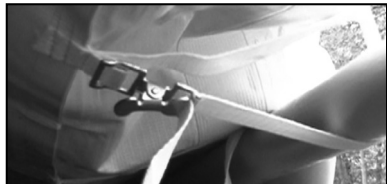

9. Attach the base plates to the legs (6’8” brown, or 7’8” black), securing with a pin.



10. In windy conditions, locate the downwind side of the tent to lift first; this keeps the wind from catching the tent.

11. Step on the base plate to free both hands and lift one side of the tent frame. Do not lift one corner at a time; lift the entire side of the tent. Insert corner fittings into the top of the leg, securing with a pin. Insert all pins from the outside in; this keeps the protruding section of the pin from puncturing the tent fabric.

12. While the tent is still low to the ground fasten the rest of the alligator straps around the perimeter tubing.



13. Repeat with the other side of the tent.

14. Center the tent top on the frame by hiding the seams behind the rafters and tightening the straps. Guide excess strap through the metal slide on the alligator clip.

15. Place stakes 5’ out from each leg; drive stakes into the ground so that approximately 6” or less of the stake is showing.

16. Attach ratchet straps or ropes to the stakes (ratchet assemblies are standard on all Celina Classic Series Gable Frame Tents):

Ratchets: Attach the ratchet buckle with loop strap (A) to the stakes by turning the 6” loop at the end of the ratchet inside out and pull the strap through the loop to create a noose and pull tight over the stake. Take the loop strap (B) attached to the tent and pull it through the reel bars slot of the ratchet (ratchet buckle needs to have handle facing upward at all times) and pull the loop strap (B) back towards the tent approximately 1 ½ feet. Hold the strap at this point with one hand and begin to crank the ratchet handle back and forth.

Ropes: Attach the rope around the fitting at each leg location. Tie the bottom end of the rope to the stake using a Double Loop Clove Hitch Knot - Gripping the rope down from the grommet in your left hand, take the opposite end and create two loops that overlap. Move the first loop (located on the bottom) so that it slightly overlaps on top of the second; put loops over the stake through the center gap created by the overlapping loops. Pull tight with the excess rope.

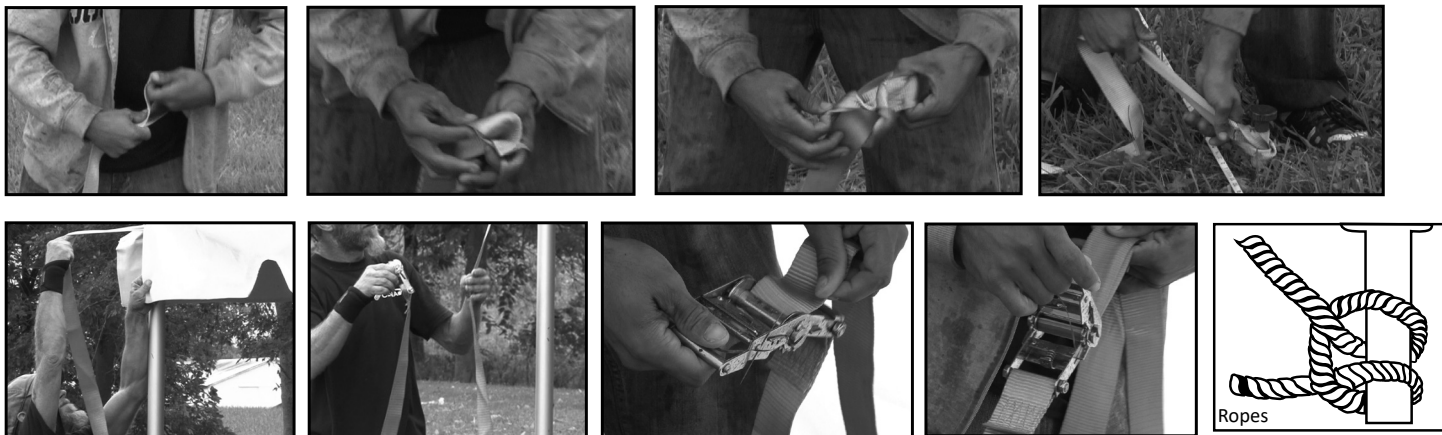

17. Roll excess ratchet straps and secure into the ratchet buckle.



18. The tent top should now be complete. If sidewalls are desired, unroll the sidewalls between the stakes and the legs around the perimeter of the tent. Starting at a leg, clip the sidewall snap hooks to the rope line that is attached to the tent top.

Sidewall Rope Tensioning: For new tents and during its life cycle, it may be necessary to tighten the sidewall support rope that runs the perimeter of the tent top. After the tent has been set up and tensioned, locate the corner where the sidewall rope starts and stops. Securely tie off one end of the rope. While pulling against the tie-off point, work your way around the perimeter of the tent, pulling out any unnecessary rope slack. Tie off the opposite end of the rope once reached.

Striking Instructions

1. Loosen all ratchet strap assemblies.
2. Remove the side legs.
3. Unfasten all anchoring devices and alligator straps from the perimeter tubing (with the exception of 2 at each corner).
4. Remove 2 corner legs from one side and carefully set the tent frame on the ground.
5. Repeat with opposite side.
6. Unfasten the rest of the straps, completely disconnecting the tent top from the frame and stakes.
7. Roll out a drop cloth next to the frame.
8. Carefully remove the tent top from the frame, lifting up on the fabric or “flapping” it to create a cushion of air.
9. Unlace the tent top:
 - a. Separate the valance hook and loop. Unclip the rain flap until the lace line tie-off is accessed.
 - b. Untie knot and unlace the tent top section while disconnecting the rain flap.
10. Fold and roll the tent top as tight as possible. Remember not to stand or walk on the tent top fabric.
11. Bagging (always use a drop cloth to protect the tent top from dirt and abrasions while bagging):
 - a. For Wrap-Around Tent Bag:
 - i. Lay the bag next to the tent top with the side-release buckles facing down. Roll the tent top onto the center of the bag.
 - ii. Connect the two short male and female side-release buckles; pull tight.
 - iii. Connect the remaining side-release buckle and pull tight.
 - b. For Round-Bottom Bag:
 - i. Place the folded tent top into the upright vertical position.
 - ii. Pull the round bottom tent bag over the upright tent top.
 - iii. Turn the tent top and bag over, pull the draw string tight and tie off.
12. Fold and roll up the drop cloth.
13. Disassemble all of the cables.
14. Disassemble all of the corner, side tee, and center crown fittings by removing the pins and sliding the tubing off of the fittings. Work from the perimeter of the frame inward.
15. Remove all stakes.

FLAME RESISTANCE

Celina fabrics are inherently flame resistant. Open flames should never be used under any tent, canopy, structure, or shelter. Fabrics meet or exceed one or more of the following flammability specifications:

NFPA-701	CPAI-84	ASTM D 6413
BS 5438	BS 7837 (1996)	DIN 4102-B1

TENT CARE

For maximum life of Celina fabrics, Celina recommends regular cleaning with the use of a soft brush with neutral soaps or cleaners, such as Celina Cleaning Products, Ivory dish soap, or warm water. Thorough rinsing and drying is required before storing the fabric.

Things that will cause premature degradation and may reduce life expectancy of a tent:

- Improper handling during installation/dismantling on rough surfaces will create pinholes and abrasions. ALWAYS USE A DROP CLOTH/GROUND CLOTH DURING INSTALLATION AND DISMANTLING.
- Walking on the fabric during installation/dismantling will create pinholes and abrasions.
- Extended use of the tent without cleaning
- Accumulation of dirt on the vinyl surface will promote the growth of mold and mildew and premature wear.
- Storage of vinyl that has not been dried thoroughly. Even a slightly damp product can promote the growth of mildew when folded and stored. Mold and mildew may require harsh cleaners to remove, which may cause premature wear. The best solution is to take every precaution to keep mold and mildew from growing in the first place. NEVER STORE A TENT, CANOPY, STRUCTURE, OR SHELTER IN A WET OR DAMP CONDITION.
- Harsh detergents and cleaners, which contain a solvent or bleach. The longer the exposure of PVC vinyl to these products, the more it will reduce the life of the PVC vinyl.
- High-abrasive cleaners, including wire brushes, power washers and/or commercial washing machines will result in premature wear and deterioration of tent fabrics.
- Wind whip – Loosely tensioned fabric that whips in the wind will damage over time.

Vinyl Repair

Celina's repair products provide an easy solution to tears, punctures, or holes. Repair kits and tools are available online at www.GetTent.com or by contacting Celina.

PRODUCT WARRANTY

Celina Tent Inc. warrants that this product will be free from defects in material and workmanship for a period of one (1) year following the date of purchase. Defects are limited to any defect which is a result of the manufacturing process. Excluded are holes, punctures, or other damages which can be caused during normal installation of a tent whenever proper procedures are not followed. Celina at its option will repair or replace this product or any component of product found to be defective during this warranty period. This warranty is valid for the original purchaser only, and is not transferable. This warranty does not cover normal wear or damage resulting from negligent use or misuse of the product, use contrary to instructions, repairs or alterations by anyone other than Celina, or forces of nature. Celina Tent is not responsible for methods that installers may choose to erect and secure the tent to the ground. Celina's responsibility is limited to the manufacture of the tent parts and materials.

This warranty is in lieu of all other warranties, and there are no warranties, expressed or implied, including warranties of merchantability of fitness for a particular purpose, which extend beyond the description on the face hereof. Celina Tent Inc. shall not be liable for any incidental or consequential damages. Some jurisdictions do not allow the exclusion of implied warranties or the imitation on incidental or consequential damages, so the above exclusions and limitations may not apply to you.

CALL BEFORE YOU DIG OR STAKE

STATE	CENTER	PHONE
Alabama	Alabama Line Location	800/292-8525
Alaska	Locate Call Center of Alaska	800/478-3121
Arizona	Arizona Blue Stake	800/782-5348
Arkansas	Arkansas One Call System	800/482-8998
California	Underground Service Alert	800/227-2600
Colorado	Utility Notification Center of Colorado	800/922-1987
Connecticut	Call Before You Dig	800/922-4455
Delaware	Miss Utility of Delaware	800/282-8555
Florida	Call Sunshine	800/432-4770
Georgia	Utilities Protection Center	800/282-7411
Hawaii	Underground Service Alert North	800/227-2600
	Underground Service Alert South	800/227-2600
Idaho	Palouse Empire Underground	800/822-1974
	Utilities Underground Location Center	800/424-5555
	Dig Line	800/342-1585
	One Call Concepts - Idaho	800/626-4950
	Shoshone County One Call	800/398-3285
Illinois	Chicago Utility Alert Network	800/892-0123
Indiana	Indiana Underground Plant Protection	800/382-5544
Iowa	Underground Plant Location Service	800/292-8989
Kansas	Kansas One-Call Center	800/344-7233
Kentucky	Kentucky Underground Protection	800/752-6007
Louisiana	Louisiana One Call System	800/272-3020
Maine	Dig Safe - Maine	888/344-7233
Maryland	Miss Utility	800/257-7777
	Miss Utility of DESMARVA	800/282-8555
Massachusetts	Dig Safe-Massachusetts	888/344-7233
Michigan	Miss Dig System	800/482-7171
Minnesota	Gopher State One Call	800/252-1166
Mississippi	Mississippi One Call System	800/227-6477
Missouri	Missouri One Call System	800/344-7483
Montana	Utilities Underground Location Center	800/424-5555
	Montana U-Dig	800/551-8344
Nebraska	Diggers Hotline	800/331-5666
Nevada	Underground Service Alert North	800/227-2600
New Hampshire	Dig Safe-New Hampshire	888/344-7233
New Jersey	Garden State Underground	800/272-1000
New Mexico	New Mexico One Call System	800/321-2537
	Las Cruces-Dona Ana Utility Council	888/526-0400

STATE	CENTER	PHONE
New York	Dig Safely New York	800/926-7962
	New York City-Long Island One Call	800/272-4480
North Carolina	North Carolina One Call	800/634-4949
North Dakota	North Dakota One Call	800/795-0555
Ohio	Ohio Utilities Protective Service	800/362-2764
	Oil & Gas Producers Underground	800/925-2988
Oklahoma	Call Okie	800/522-6543
Oregon	Oregon Utilities Notification Center	800/332-2344
Pennsylvania	Pennsylvania One Call System	800/242-1776
Rhode Island	Dig Safe-Rhode Island	888/344-7233
South Carolina	Palmetto Utility Protection Service	800/922-0983
South Dakota	South Dakota One Call	800/781-7474
Tennessee	Tennessee One-Call System	800/351-1111
Texas	Texas One Call System	800/245-4545
	Texas Excavation Safety System	800/344-8377
	Lone Star Notification System	800/669-8344
Utah	Blue Stakes Location Center	800/622-4111
Vermont	Dig Safe - Vermont	888/344-7233
Virginia	Miss Utility of Virginia	800/552-7001
	Miss Utility	800/257-7777
Washington	Miss Utility of DELMARVA	800/441-8355
	Notification Center	800/424-5555
	Utilities Council of Cowlitz County	360/425-2506
	Upper Yakima City Underground	800/553-4344
	Inland Empire Utility Coordinating	509/456-8000
West Virginia	Miss Utility of West Virginia	800/245-4848
Wisconsin	Diggers Hotline	800/242-8511
Wyoming	Wyoming One Call	800/348-1030
	Call Before you Dig Wyoming	800/849-2476
District of Columbia	Miss Utility	800/257-7777
Canada	Alberta One Call	800/242-3447
	Ontario	800/400-2255
	Info-Excavation (Quebec)	800/663-9228
	BC One Call	800/474-6886
	Manitoba - Winnipeg	240/480-1212
	Manitoba & Saskatchewan Safe	800/827-5094

SUPPORT

For technical questions or replacement parts, please contact:

Celina Tent, Inc. / GetTent.com
 5373 State Route 29
 Celina, Ohio 45822-9210 USA

Telephone: 419-586-3610

Fax: 419-584-0949

Website: www.GetTent.com

Email: support@celinatent.com

YouTube: <http://www.youtube.com/user/celinatent>

Facebook: <http://www.facebook.com/celinatent>

Google +: <http://goo.gl/qvVdv>

Twitter: <http://twitter.com/celinatent>

LinkedIn: <http://www.linkedin.com/company/celina-tent-fabric-structures>