

# 20' x 40' CLASSIC SERIES POLE TENT 1 PC. PRODUCT MANUAL

ver.20170611



Read this manual before using this product. Failure to do so can result in serious injury.  
SAVE THIS MANUAL



## NOTICE

The warnings, cautions, and instructions discussed in this instruction manual cannot cover all possible conditions and situations that may occur. It must be understood by the user that common sense and caution are factors which cannot be built into this product, but must be supplied by the installer and/or user.

Tent, canopy, structure, and shelter products are manufactured for use as temporary structures and do not meet structural code unless specified. Since weather is unpredictable, the installer/end user must incorporate their own good judgment, common sense and knowledge of local conditions with the installation instruction guidelines. The installer is responsible for anticipating weather severity for proper time and method of installation.

## WARNING SYMBOLS AND DEFINITIONS

	This is the safety alert symbol. It is used to alert you to potential personal injury hazards. Obey all safety messages that follow this symbol to avoid possible injury or death.
<b>▲WARNING</b>	Indicates a hazardous situation which, if not avoided, could result in death or serious injury.
<b>▲CAUTION</b>	Indicates a hazardous situation which, if not avoided, could result in minor or moderate injury.

**Description**



**20' x 40' Classic Series Pole Tent, 1 Piece**

Celina's Classic Series Pole Tent is the most commonly used tent throughout the tent and party industry as a result of the high quality and fast tent installation process. The vinyl tent top is supported by sectional center poles rather than a frame which requires much less time and effort. The Classic Pole Tent has an elegant scalloped valance which can provide any consumer with the required appearance needed for any occasion.

**Suggested Equipment**

Drop cloth or ground cloth, sledge hammer, or electric / gas breaker hammer fitted with stake driver bit, stake puller.

**Colors available by special order**

- White & Red (5051)
- White & Green (5052)
- White & Blue (5053)

**Classic Series Pole Tent Specifications**

Width	20 ft. / 6m	
Length	40 ft. / 12m	
Area	800 ft <sup>2</sup> / 72 m <sup>2</sup>	
Eave Height	7' / 2.13m	8' / 2.44m
Overall Height	14'10" / 4.52m	15'10" / 4.83m
Pitch	7' / 2.13m	
Complete Weight Aluminum	567 Lbs. / 257 Kg.	585 Lbs. / 265 Kg.
Complete Weight Galvanized	648 Lbs. / 294 Kg.	670 Lbs. / 304 Kg.
Series / Brand	Classic	
Class	Pole	
Center Pole	Yes	
Style / Shape	Traditional	
Expandable	No	
Custom Printing Available	Yes	
Fabric Material	PVC Coated Polyester	
Fabric Material Weight	16 oz. / yd <sup>2</sup> / 540 gsm	
Fabric Translucency	Blockout	
Water Repellency	Waterproof	
Flame Resistant	Yes	
UV Resistant	Yes	
Mold and Mildew Resistant	Yes	
Frame / Pole Material	Aluminum OR Galvanized	
Longest Component	7'10" / 2.4m	8'10" / 2.7m
Persons required for setup	2	
Occupancy	80 Sit Down Dinner - 133 Cathedral Seating	





**SAFETY**

**INSTALLATION**

**MAINTENANCE**

**CONTACTS**

## PERSONAL SAFETY

-  **STAY ALERT:** Watch what you are doing, and use common sense when installing/striking a tent, canopy, structure, or shelter. Do not setup/strike while under the influence of drugs, alcohol, or medication. A moment of inattention may result in serious personal injury.
-  **DO NOT OVER LIFT:** The equipment may be heavy and may require 2 or more people to lift and move.
-  **DO NOT OVERREACH:** Keep proper footing and balance at all times. Use a ladder when necessary.
-  **DRESS PROPERLY:** Do not wear loose clothing or jewelry. Contain long hair. Keep hair, clothing, and hands/gloves away from power equipment and snag or pinch points.
-  **USE SAFETY EQUIPMENT:** Eye protection, safety shoes, hard hats, or hearing protection must be used for appropriate conditions.

## WEATHER

Since weather is unpredictable, the installer/end user must incorporate their own judgment, common sense and knowledge of local conditions with the installation instruction guidelines. The installer is responsible for anticipating weather severity for proper time and method of installation.

- **Rain:** **⚠WARNING** Rain water can collect on the tent fabric and cause ‘ponding’ or ‘water pocketing’ under certain weather conditions, especially if the tent is not installed and tensioned correctly. The additional weight from the water will cause the tent to sag and ponding will continue to get worse. The weight can destroy the tent fabric and/or cause the poles and baseplates to sink into the soil. Highly saturated soil will cause the stakes to lose their holding power.
- **Wind:** **⚠WARNING** Wind or wind and rain can cause the tension of the tent to change by loosening ratchet assemblies, pulling stakes, and or causing the poles to shift or sink. It is very important to do routine maintenance checks and maintain proper tension on the tent top at all times especially if weather conditions are such that ratchets are beginning to loosen
- **Lightning:** **⚠WARNING** Immediately evacuate the tent until the chance of a lightning strike is no longer present.
- **Snow:** Tents, canopies, structures, and shelters are not designed to carry any type of snow loading. These products should not be used if snow of any kind is present, and must be evacuated immediately.

## SITE SELECTION

Site selection is extremely important. The installer must adhere to local building codes and fire regulations. The installer must evaluate each installation site and determine the proper securing and anchoring method and device appropriate for the conditions. Some soils require different staking or securing methods than what may be/have been purchased with the standard tent package. Celina Tent’s instructions, YouTube videos, and Layout Handbook summarize all the functions of each product, the rules for using them and suggestions for their use. However, field situations, site conditions, weather and local experience may mandate other methods. Review the following conditions at the proposed site and plan accordingly.

The best site qualities are:

- **Location:** Elevated, level, and clear of debris
- **Soil Conditions:** Adequate for stable anchoring
- **Space:** Adequate space for the perimeter and stake lines
- **Surface Type:** Grass, Gravel, Concrete, Asphalt, Wood
- **Site Access:** Materials and services can easily be delivered to the site

**⚠WARNING** Also allow for:

- **Overhead Obstructions:** Electrical/telephone lines, tree branches
- **Underground Utilities:** Electric, Gas, Oil, Steam, Telephone, CATV, Water, Sewer
- **Weather Effects:** Monitor for extreme weather conditions and evacuate if necessary
- **Emergency Exit Capabilities:** Provide evacuation routes in case of a fire or bad weather

## Before You Stake

By law you are required to contact your local “Call before you dig” number before you plan to dig or drive tent stakes / anchors. After calling, your local utility companies will mark the location of all underground utility lines. Laws from state to state vary on how far in advance you must call. Planning ahead and checking with your state’s program is always a smart idea. Failure to obtain a utility line location before digging can result in a substantial fine or serious injury. Please find your local “call before your dig number” in the contacts section of this manual.

**⚠WARNING** Prior to staking, be sure that no underground utilities are present. Celina is not responsible for methods that installers may choose to erect and secure the tent, canopy, structure, or shelter to the site surface. Celina’s responsibility is limited to the manufacture of the tent parts and materials. It is the installer’s responsibility, not Celina’s, to determine the appropriate number of stakes to meet the necessary wind loads on the installation site.

**⚠WARNING** Soil and setup conditions can vary greatly between installation sites. It is the installer’s responsibility to be sure the staking is adequate for each site on each setup. Additional staking, tiebacks, and/or stake bars may be required in order to safely setup and secure the product.

**⚠WARNING** The number of stakes suggested in this manual routinely does not meet the relevant local codes of the installation site. The number of stakes included in the standard kit will, in most cases, keep the tent, canopy, structure, or shelter setup. Due to various soil conditions the standard staking kit may be inadequate to keep the tent secure in high winds and wet or threatening weather. Regardless of the number of stakes included in standard kits, Celina makes no representation or warranty as to whether this is sufficient to meet the requirements for your installation site(s).

## Staking Basics

A properly driven stake will have 6” or less of the head exposed. The deeper that the stake is driven, the greater holding strength the stake will have. Anchoring stakes must be driven deep and vertical.

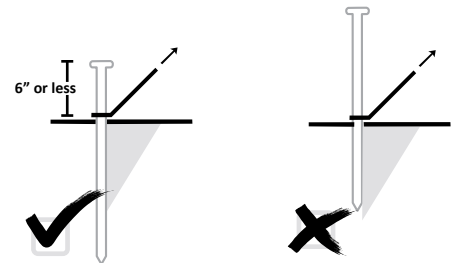

Stakes driven vertically have a greater holding strength than stakes driven at an angle. Vertically is defined as straight up down or angled up to 10° away from the tent, canopy, structure, or shelter.

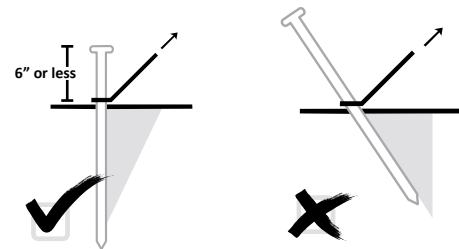

For more information on staking and soil conditions, please view Celina Tent’s 15 part video series on YouTube.com or follow this link: Stake Pull Demonstration (1/15) [www.goo.gl/v0XhV](http://www.goo.gl/v0XhV)

# REQUIRED HARDWARE

## 20' x 40' Classic Series Pole Tent, 1 Piece

Key	Description	Size	Qty.	Picture
●	Side Pole(s) <small>*Pole pin not included in overall pole height</small>	*7' OR 8'	12	
★	2pc. Center Pole(s) <small>*Pole pin and insert not included in overall pole height</small>	*14' OR 15'	3	
○	Stakes	36"	16	
	A Ratchet Buckle with Loop Strap	2" Ratchet 5' Loop	16	
	B Loop Strap	8' Loop	16	

NOTE: When the Ratchet Buckle with Loop Strap (A) is connected to Loop Strap (B) it forms the Ratchet Assembly.

	Tent Top	20'x40'	1	
	Tent Bag	B	1	<p>Wrap Around Tent Bag      OR      Round Bottom Tent Bag</p>

### OPTIONAL ACCESSORIES

	Sidewall(s)	20'	6	
--	-------------	-----	---	--

### MINIMUM STAKING LAYOUT

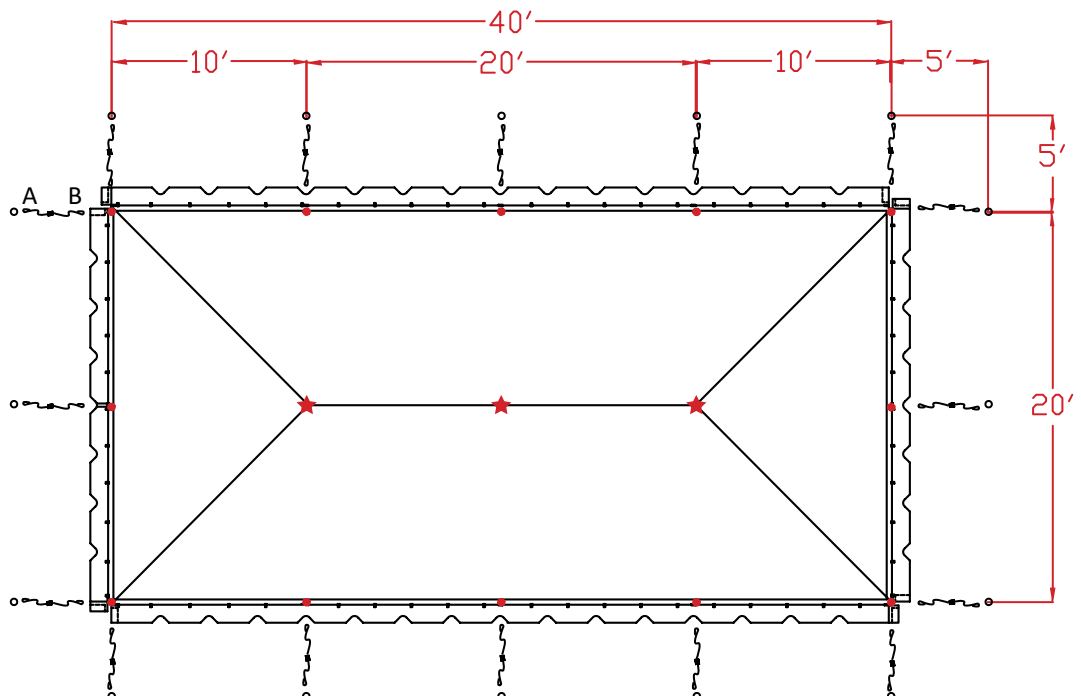
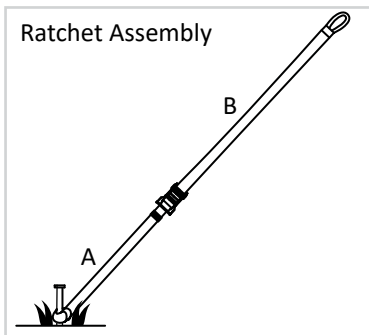

SAFETY

INSTALLATION

MAINTENANCE

CONTACTS



## Preliminary set-up

1. Layout all of the staking hardware around the tent (minimum staking):
  - a. 2 stakes go to each corner location (place 90° apart).
  - b. 1 stake goes to the remaining grommet locations.
2. Place the stakes approximately 5' from the grommet locations. Drive all of the stakes into the ground vertically until approximately 6" of the stake is left exposed.
3. If using ratchets:
  - a. Distribute 1 ratchet buckle with loop strap (A) and 1 loop strap (B) for every stake (disregard if installing a rope tent).
  - b. Attach the ratchet buckle with loop strap (A) to the stakes: turn the 6" loop at the end of the ratchet buckle with loop strap (A) inside out and pull the strap through the loop to create a noose and pull tight over the stake.



4. Place 1 pole to each grommet location.
5. Roll out drop cloth to protect the tent from dirt and abrasions.

## Set Up Instructions

1. Remove tent top from the bag. Unroll and unfold the tent top on the desired spot to be covered, keeping the tent top square. Pull the perimeter of the tent as tight as possible; the center of the tent top will not be tight or lay flat due to the peak of the tent. Do not walk or stand on the tent fabric.

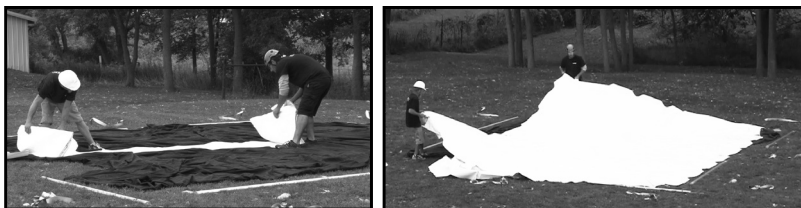

2. Attach the Loop Strap (B) or ropes to the tent top; ratchet assemblies are standard on all Celina Classic Series Pole Tents:

**Ratchets:** Attach the loop strap (B) end to the metal "O" ring on the tent top and assemble the ratchet assembly. Take the loop strap (B) attached to the tent and pull it through the reel bars slot of the Ratchet Buckle with Loop Strap (A) attached to the stake (ratchet buckles needs to have handle facing upward at all time) and pull the loop strap (B) back towards the tent approximately 1 ½ feet. Hold the strap at this point with one hand and begin to crank the ratchet handle back and forth with the other hand until the reel bars have turned at least 2 times as this eliminates the chance of slippage.

**Ropes:** Attach the rope to the metal "O" ring on the tent top. Tie the other end of the rope to the stake using a Double Loop Clove Hitch Knot - Gripping the rope down from the grommet in your left hand, take the opposite end and create two loops that overlap. Move the first loop (located on the bottom) so that it slightly overlaps on top of the second; put loops over the stake through the center gap created by the overlapping loops. Pull tight with the excess rope. Repeat at all pole locations.



# INSTALLATION INSTRUCTIONS

SAFETY

3. The corner poles are now ready to be erected. Insert the pole pin through the metal "O" ring and the brass grommet (Very Important: make sure the pin goes through both the 'O' Ring and grommet; if done improperly this may cause damage to the tent top). Set the corner pole vertically straight and tighten the ratchets to keep the poles erect. Repeat at all 4 corners.



4. Tie off the jump rope attached at each pole location. This rope is used to keep the pole in place in the wind so that the tent does not lift off the side pole pin. Secure the jump rope by pulling it six to twelve inches down the pole, bringing it around the pole and then between the pole and the rope itself. Pull it back taut to create tension on the vertical length. Now wrap the rope around the pole and vertical portion of the jump rope creating a tight coil that keeps the rope from slipping up. On the last coil, pull the end of the rope through to tie it off. (see diagram)

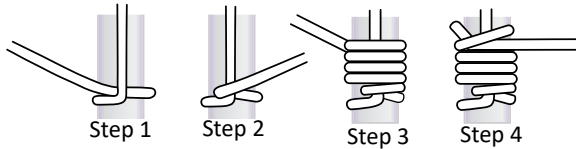

5. Assemble the center pole.



6. Insert the center pole pin through the center "O" ring and brass grommet; make sure that the pin is not caught on any part of the tent top. Lift the top using the center pole and set pole at an angled position so the top is completely off the ground.

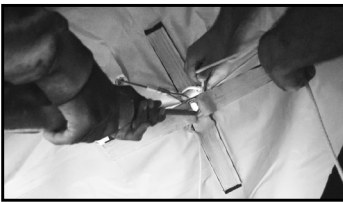

7. Tie off the jump rope attached the center pole(s) location (eye level 5-6 feet).



8. Remove the drop cloth.

9. Lift the center pole into a vertical position.

10. Loosely install the side poles while tightening all corner ratchets until the corner poles are vertically straight. Be sure to work your way around the tent, tightening and loosening ratchets until the perimeter of the tent is taut.

11. Secure the side poles by tightening the ratchets at each location.

INSTALLATION

MAINTENANCE

CONTACTS

12. Roll excess ratchet straps and secure into the ratchet buckle.



13. The tent top should now be complete. If sidewalls are desired, unroll the sidewalls between the stakes and the side poles around the perimeter of the tent. Starting at a side pole, clip the sidewall snap hooks to the rope line that is attached to the tent top.

**Sidewall Rope Tensioning:** For new tents and during its life cycle, it may be necessary to tighten the sidewall support rope that runs the perimeter of the tent top. After the tent has been set up and tensioned, locate the corner where the sidewall rope starts and stops. Securely tie off one end of the rope. While pulling against the tie-off point, work your way around the perimeter of the tent, pulling out any unnecessary rope slack. Tie off the opposite end of the rope once reached.



## Striking Instructions

1. Loosen the ratchet buckle assemblies and remove all side poles leaving only the corner poles.
2. Loosen and angle the center pole to relieve tension.
3. Roll out the drop cloth underneath the tent top.
4. Remove the center pole.
5. Loosen the corner ratchets or ropes and remove the corner poles.
6. Disconnect all of the ratchet assemblies. Remove the ratchet buckle with loop straps (A) from the stakes and loop straps (B) from the tent top. Remove stakes.
7. Fold and roll the tent top as tight as possible. Remember not to stand or walk on the tent top fabric.
8. Bagging (always use a drop cloth to protect the tent top from dirt and abrasions while bagging):
  - a. For Wrap-Around Tent Bag:
    - i. Lay the bag next to the tent top with the side-release buckles facing down. Roll the tent top onto the center of the bag.
    - ii. Connect the two short male and female side-release buckles; pull tight.
    - iii. Connect the remaining side-release buckle and pull tight.
  - b. For Round-Bottom Tent Bag:
    - i. Place the folded tent top into the upright vertical position.
    - ii. Pull the round bottom tent bag over the upright tent top.
    - iii. Turn the tent top and bag over, pull the draw string tight and tie off.
9. Fold and roll up the drop cloth.



## FLAME RESISTANCE

Celina fabrics are inherently flame resistant. Open flames should never be used under any tent, canopy, structure, or shelter. Fabrics meet or exceed one or more of the following flammability specifications:

NFPA-701	CPAI-84	ASTM D 6413
BS 5438	BS 7837 (1996)	DIN 4102-B1

## TENT CARE

For maximum life of Celina fabrics, Celina recommends regular cleaning with the use of a soft brush with neutral soaps or cleaners, such as Celina Cleaning Products, Ivory dish soap, or warm water. Thorough rinsing and drying is required before storing the fabric.

### Things that will cause premature degradation and may reduce life expectancy of a tent:

- Improper handling during installation/dismantling on rough surfaces will create pinholes and abrasions. ALWAYS USE A DROP CLOTH/GROUND CLOTH DURING INSTALLATION AND DISMANTLING.
- Walking on the fabric during installation/dismantling will create pinholes and abrasions.
- Extended use of the tent without cleaning
- Accumulation of dirt on the vinyl surface will promote the growth of mold and mildew and premature wear.
- Storage of vinyl that has not been dried thoroughly. Even a slightly damp product can promote the growth of mildew when folded and stored. Mold and mildew may require harsh cleaners to remove, which may cause premature wear. The best solution is to take every precaution to keep mold and mildew from growing in the first place. NEVER STORE A TENT, CANOPY, STRUCTURE, OR SHELTER IN A WET OR DAMP CONDITION.
- Harsh detergents and cleaners, which contain a solvent or bleach. The longer the exposure of PVC vinyl to these products, the more it will reduce the life of the PVC vinyl.
- High-abrasive cleaners, including wire brushes, power washers and/or commercial washing machines will result in premature wear and deterioration of tent fabrics.
- Wind whip – Loosely tensioned fabric that whips in the wind will damage over time.

### Vinyl Repair

Celina's repair products provide an easy solution to tears, punctures, or holes. Repair kits and tools are available online at [www.GetTent.com](http://www.GetTent.com) or by contacting Celina.

## PRODUCT WARRANTY

Celina Tent Inc. warrants that this product will be free from defects in material and workmanship for a period of one (1) year following the date of purchase. Defects are limited to any defect which is a result of the manufacturing process. Excluded are holes, punctures, or other damages which can be caused during normal installation of a tent whenever proper procedures are not followed. Celina at its option will repair or replace this product or any component of product found to be defective during this warranty period. This warranty is valid for the original purchaser only, and is not transferable. This warranty does not cover normal wear or damage resulting from negligent use or misuse of the product, use contrary to instructions, repairs or alterations by anyone other than Celina, or forces of nature. Celina Tent is not responsible for methods that installers may choose to erect and secure the tent to the ground. Celina's responsibility is limited to the manufacture of the tent parts and materials.

This warranty is in lieu of all other warranties, and there are no warranties, expressed or implied, including warranties of merchantability of fitness for a particular purpose, which extend beyond the description on the face hereof. Celina Tent Inc. shall not be liable for any incidental or consequential damages. Some jurisdictions do not allow the exclusion of implied warranties or the imitation on incidental or consequential damages, so the above exclusions and limitations may not apply to you.

# CALL BEFORE YOU DIG OR STAKE

STATE	CENTER	PHONE
Alabama	Alabama Line Location	800/292-8525
Alaska	Locate Call Center of Alaska	800/478-3121
Arizona	Arizona Blue Stake	800/782-5348
Arkansas	Arkansas One Call System	800/482-8998
California	Underground Service Alert	800/227-2600
Colorado	Utility Notification Center of Colorado	800/922-1987
Connecticut	Call Before You Dig	800/922-4455
Delaware	Miss Utility of Delaware	800/282-8555
Florida	Call Sunshine	800/432-4770
Georgia	Utilities Protection Center	800/282-7411
Hawaii	Underground Service Alert North	800/227-2600
	Underground Service Alert South	800/227-2600
Idaho	Palouse Empire Underground	800/822-1974
	Utilities Underground Location Center	800/424-5555
	Dig Line	800/342-1585
	One Call Concepts - Idaho	800/626-4950
	Shoshone County One Call	800/398-3285
Illinois	Chicago Utility Alert Network	800/892-0123
Indiana	Indiana Underground Plant Protection	800/382-5544
Iowa	Underground Plant Location Service	800/292-8989
Kansas	Kansas One-Call Center	800/344-7233
Kentucky	Kentucky Underground Protection	800/752-6007
Louisiana	Louisiana One Call System	800/272-3020
Maine	Dig Safe - Maine	888/344-7233
Maryland	Miss Utility	800/257-7777
	Miss Utility of DESMARVA	800/282-8555
Massachusetts	Dig Safe-Massachusetts	888/344-7233
Michigan	Miss Dig System	800/482-7171
Minnesota	Gopher State One Call	800/252-1166
Mississippi	Mississippi One Call System	800/227-6477
Missouri	Missouri One Call System	800/344-7483
Montana	Utilities Underground Location Center	800/424-5555
	Montana U-Dig	800/551-8344
Nebraska	Diggers Hotline	800/331-5666
Nevada	Underground Service Alert North	800/227-2600
New Hampshire	Dig Safe-New Hampshire	888/344-7233
New Jersey	Garden State Underground	800/272-1000
New Mexico	New Mexico One Call System	800/321-2537
	Las Cruces-Dona Ana Utility Council	888/526-0400

STATE	CENTER	PHONE
New York	Dig Safely New York	800/926-7962
	New York City-Long Island One Call	800/272-4480
North Carolina	North Carolina One Call	800/634-4949
North Dakota	North Dakota One Call	800/795-0555
Ohio	Ohio Utilities Protective Service	800/362-2764
	Oil & Gas Producers Underground	800/925-2988
Oklahoma	Call Okie	800/522-6543
Oregon	Oregon Utilities Notification Center	800/332-2344
Pennsylvania	Pennsylvania One Call System	800/242-1776
Rhode Island	Dig Safe-Rhode Island	888/344-7233
South Carolina	Palmetto Utility Protection Service	800/922-0983
South Dakota	South Dakota One Call	800/781-7474
Tennessee	Tennessee One-Call System	800/351-1111
Texas	Texas One Call System	800/245-4545
	Texas Excavation Safety System	800/344-8377
	Lone Star Notification System	800/669-8344
Utah	Blue Stakes Location Center	800/622-4111
Vermont	Dig Safe - Vermont	888/344-7233
Virginia	Miss Utility of Virginia	800/552-7001
	Miss Utility	800/257-7777
Washington	Miss Utility of DELMARVA	800/441-8355
	Notification Center	800/424-5555
	Utilities Council of Cowlitz County	360/425-2506
	Upper Yakima City Underground	800/553-4344
	Inland Empire Utility Coordinating	509/456-8000
West Virginia	Miss Utility of West Virginia	800/245-4848
Wisconsin	Diggers Hotline	800/242-8511
Wyoming	Wyoming One Call	800/348-1030
	Call Before you Dig Wyoming	800/849-2476
District of Columbia	Miss Utility	800/257-7777
Canada	Alberta One Call	800/242-3447
	Ontario	800/400-2255
	Info-Excavation (Quebec)	800/663-9228
	BC One Call	800/474-6886
	Manitoba - Winnipeg	240/480-1212
	Manitoba & Saskatchewan Safe	800/827-5094

SAFETY

INSTALLATION

MAINTENANCE

## SUPPORT

**For technical questions or replacement parts, please contact:**

Celina Tent, Inc. / GetTent.com  
 5373 State Route 29  
 Celina, Ohio 45822-9210 USA

**Telephone:** 419-586-3610

**Fax:** 419-584-0949

**Website:** [www.GetTent.com](http://www.GetTent.com)

**Email:** [support@celinatent.com](mailto:support@celinatent.com)

**YouTube:** <http://www.youtube.com/user/celinatent>

**Facebook:** <http://www.facebook.com/celinatent>

**Google +:** <http://goo.gl/qvVdv>

**Twitter:** <http://twitter.com/celinatent>

**LinkedIn:** <http://www.linkedin.com/company/celina-tent-fabric-structures>

CONTACTS